

DEPARTMENT OF ENERGY  
REMEOIAL ACTION PROGRAM ANNUAL MEETING  
OCTOBER 18-20, 1988

THE IMPACT OF PROPOSED EPA GROUNDWATER STANDARDS ON  
UMTRA PROJECT DISPOSAL CELL DESIGN

BY

JACK A. CALDWELL  
RON RAGER  
AND  
NED B. LARSON

UMTRA PROJECT  
TECHNICAL ASSISTANCE CONTRACTOR

## TABLE OF CONTENTS

<u>Section</u>	<u>Page</u>
1.0 INTRODUCTION . . . . .	1
2.0 TYPICAL DISPOSAL CELL DESIGNS BEFORE THE STANDARDS. . . . .	3
3.0 SPECIAL STUDIES . . . . .	5
3.1 General. . . . .	5
3.2 Geomembranes . . . . .	5
3.3 Alternate cover materials. . . . .	5
3.4 Alternate cover designs. . . . .	7
4.0 ALTERNATIVE DISPOSAL CELL DESIGN APPROACHES . . . . .	13
5.0 THE CHECKLIST DESIGN APPROACH . . . . .	14
6.0 CHECKLIST CELL DESIGN . . . . .	16
7.0 CHECKLIST APPROACH TO PERIMETER DIKE DETAIL . . . . .	22
8.0 THE CHECKLIST COVER . . . . .	24
9.0 TECHNICAL APPROACH TO THE USE OF CLAYMAX. . . . .	26
10.0 TECHNICAL APPROACH TO THE DESIGN OF SOIL COVERS . . . . .	30
11.1 IMPACT OF STANDARDS ON ALL SITES . . . . .	36
11.1 Special study implications to cell design. . . . .	36
11.2 Site-specific analysis . . . . .	36
11.3 Cost implication . . . . .	38
12.1 CASE HISTORIES . . . . .	40
12.1 Grand Junction . . . . .	40
12.2 Green River. . . . .	40
12.3 Gunnison . . . . .	41
12.4 Durango. . . . .	42
REFERENCES . . . . .	47
ATTACHMENT A, Component Elimination Criteria	

## LIST OF FIGURES

<u>Figure</u>	<u>Page</u>
2.1 Typical UMTRA Project pile layout. . . . .	4
3.1 The corrugated cover . . . . .	10
3.2 Capillary break with corrugated cover. . . . .	11
3.3 Capillary break over narrow disposal trench. . . . .	12
6.1 "Checklist" cell for relocation option . . . . .	18
6.2 "Checklist" cell: in situ option. . . . .	19
6.3 Perimeter dike removal disposal cell layout. . . . .	20
6.4 Perimeter dike erosion assessment. . . . .	21
7.1 "Checklist" perimeter dike alternates. . . . .	23
8.1 "Checklist" top cover. . . . .	25
9.1 Position of bentonite mat infiltration barrier in UMTRA covers. . . . .	28
9.2 Bentonite mat infiltration barrier on cell sideslopes. . . . .	29
10.1 Cover Design concepts for prevention of gullies. . . . .	33
10.2 Cover with inclined drainage layers and flat top . . . . .	34
10.3 Factors in the evaluation of cover components for biointrusion hazard. . . . .	35
12.1 Grand Junction proposed cover design . . . . .	43
12.2 Green River disposal cell: alternate perimeter designs. . . . .	44
12.3 Disposal cell details landfill, Gunnison, Colorado . . . . .	45
12.4 Final cover design, Durango, Colorado. . . . .	46

## LIST OF TABLES

<u>Table</u>	<u>Page</u>
3.1 Alternate cover materials. . . . .	6
11.1 Application of Special Study findings at specific sites. . . . .	37

## 1.0 INTRODUCTION

The Uranium Mill Tailings Remedial Action (UMTRA) Project involves stabilizing 24 inactive uranium mill tailings piles in 10 states. Remedial work meets standards established by the US Environmental Protection Agency (EPA). The EPA standards as initially published in 1983 required, among other things, that the remedial action be effective for at least 1,000 years, to the extent practical, and otherwise for at least 200 years. Remedial action must be designed and constructed to prevent dispersion of the tailings and other contaminated materials, and must prevent inadvertent use of the tailings by man. Remedial actions should not rely for their efficacy on maintenance, although surveillance and maintenance programs are planned.

The groundwater standards for the UMTRA Project as originally promulgated by the EPA provided for a site-by-site approach to developing appropriate measures to control seepage releases from the disposal cells and for determining the extent to which groundwater quality was affected by the remedial works. In response to a remand of the original standards by the Tenth Circuit Court of Appeals, the EPA published draft groundwater standards in late 1987 that set general standards applicable to all UMTRA Project sites.

The proposed EPA groundwater standards require protection of human health, safety, and the environment; consideration of radiological and non radiological hazards; and consistency with the requirements of the Resource Conservation and Recovery Act (RCRA), as amended. In particular, the proposed EPA groundwater standards require that the disposal cell be designed to limit seepage to ensure that at a point of compliance (generally at the downgradient toe of the facility) the Resource Conservation and Recovery Act (RCRA) Maximum Concentration Limits (MCLs), background limits, or alternate concentration limits (ACLs) are achieved in the groundwater. The establishment of ACLs must be concurred in by the Nuclear Regulatory Commission (NRC), must be as low as reasonably achievable, and satisfy certain other regulatory requirements (i.e., the water-quality protection considerations stipulated in 40 CFR Part 264.94(b)).

On publication of the proposed EPA groundwater standards, the U.S. Department of Energy (DOE) adopted a policy of complying with the standards as they affect disposal cell design and the construction of remedial works. (Compliance with those parts of the standards leading to possible groundwater restoration are postponed until promulgation of the final standards.) Publication of the proposed EPA groundwater standards created a need to reevaluate both the performance of previous UMTRA Project disposal cell designs and the extent to which these designs facilitated or led to compliance with the proposed standards.



This paper describes the special studies that were completed to identify alternative designs and materials. The paper discusses so-called "Checklist Disposal Cell and Cover Designs" that have been formulated; these checklist cells and cover designs provide guidance for the compilation, on a site-specific basis, of disposal cell designs that will lead to compliance with the proposed EPA groundwater standards. The paper describes a number of case histories of the new cells and covers adopted at specific UMTRA Project sites.

## 2.0 TYPICAL DISPOSAL CELL DESIGNS BEFORE THE STANDARDS

Figure 2.1 shows a typical UMTRA Project disposal cell design formulated prior to publication of the proposed EPA groundwater standards. In particular, the cover consists of a radon barrier of compacted clay and silt; a bedding layer of sand; and an erosion barrier of durable rock. Infiltration control is achieved by the radon barrier, made of low permeability materials that inhibit significant infiltration. The cover design is similar to that constructed at Shiprock, New Mexico; Clive, Utah; and Cannonsburg, Pennsylvania (where in addition soil and vegetation were established for aesthetic reasons on the pile); and similar to that planned for Ambrosia Lake, New Mexico.

At the time of publication of the EPA groundwater standards, similar covers and disposal cell layouts to that shown on Figure 2.1 were being considered for most of the remaining UMTRA Project sites. Construction had begun at Lakeview, Oregon, and Durango, Colorado. Designs were complete and construction about to begin at Tuba City, Arizona, and Mexican Hat, Utah. Design was significantly advanced at Grand Junction, Colorado; Belfield and Bowman, North Dakota; Falls City, Texas; and Slick Rock, Colorado.

Accordingly, the first and most immediate affect of the proposed EPA groundwater standards was to raise the urgent question: Are the current designs for the disposal cell, and in particular the cover, adequate to lead to compliance with the new standards? To answer this question, new groundwater impact analyses were performed, alternative covers considered, and other cell designs evaluated. A series of special studies was undertaken to assess technologies and design approaches that could facilitate compliance with the standards.

One of the first major consequences of the proposed EPA groundwater standards on a previously selected remedial action plan was the decision to relocate the tailings from the Monument Valley, Arizona, site to the Mexican Hat, Utah, site. Detailed analyses showed that possible cell and cover design modifications could increase remedial action costs at Monument Valley to the extent that it is more economical to relocate the tailings than to stabilize them on the site. At Gunnison, Colorado, the proposed standards have had a significant impact on the decision to relocate the tailings to a new site, called the Landfill site after the adjacent landfill disposal facility.

The impact of the proposed standards at other sites has been less dramatic than a revision of the selected disposal site location, but at most sites some and often major design modifications have resulted. These changes and the reasons for them are discussed in subsequent sections of this paper.

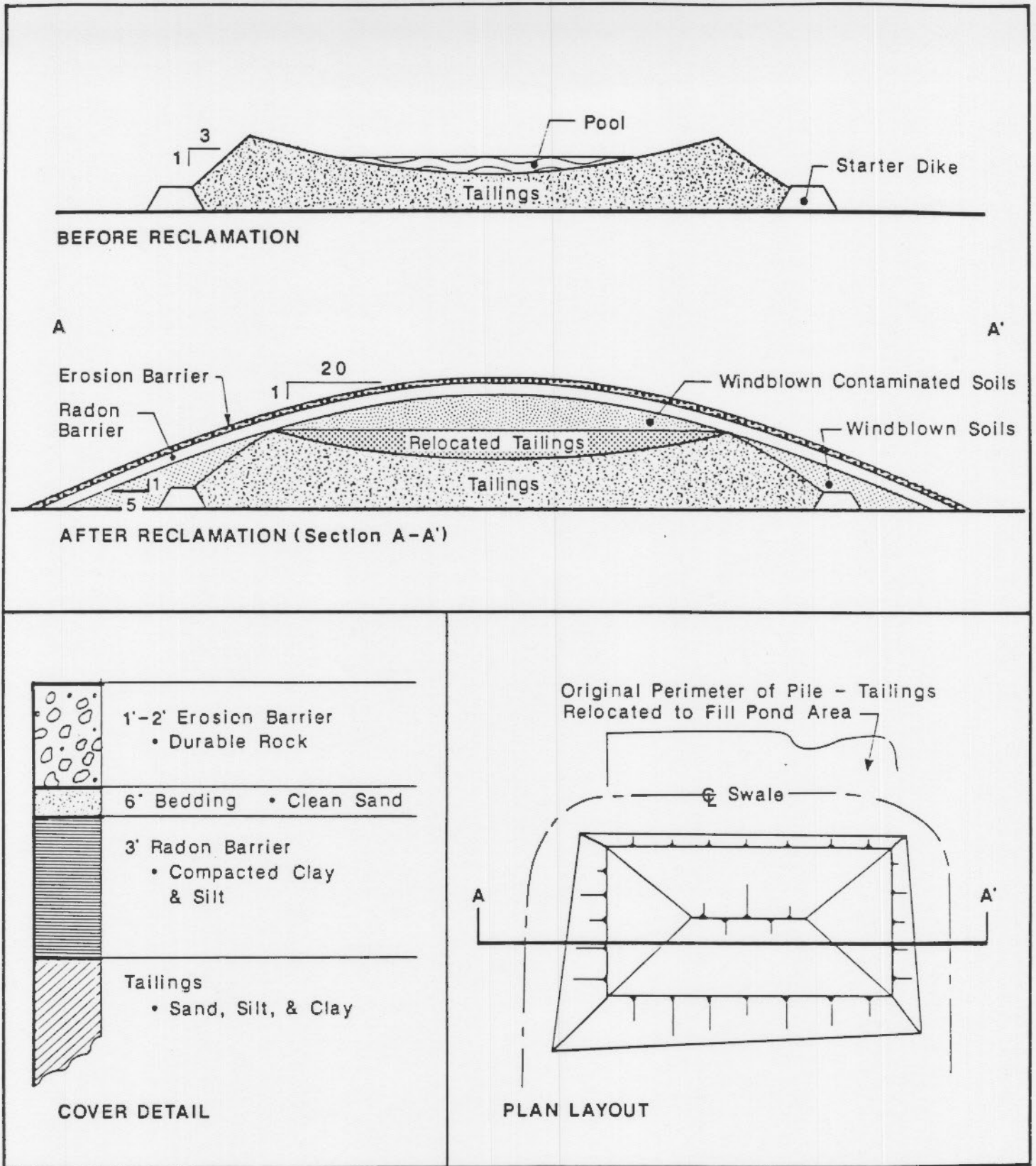

**FIGURE 2.1**  
**TYPICAL UMTRA PROJECT PILE LAYOUT**



### 3.0 SPECIAL STUDIES

#### 3.1 GENERAL

When the UMTRA Project was first undertaken, a technology development program was organized. The results of the first technology development program were incorporated as standard practice on the UMTRA Project; see the Technical Approach Document (DOE, 1988). In order to approach compliance with the proposed EPA groundwater standards as they affect disposal cell design, in an orderly manner a new technology development program was initiated. This program involved a number of special studies. The following is a discussion of the result of those studies that are relevant to and have impacted revised disposal cell designs.

#### 3.2 GEOMEMBRANES

In this special study we evaluated the potential for use of geomembranes as infiltration barriers in the covers of UMTRA Project disposal cells. The very low hydraulic conductivity (permeability) of geomembranes is well known, and if used they could significantly limit infiltration to the tailings, and hence limit seepage from the cell and the impact of contaminant leachate on the groundwater beneath and downgradient of the disposal facility.

There is evidence, based on observed performance, that geomembranes will last for 20 to 50 years. It is possible to argue rationally on the basis of the observed behavior of installed geomembranes and extrapolation of test data that geomembranes will function satisfactorily for up to 100 years and possibly longer. It is even reasonable to consider that geomembranes may continue to impede infiltration for periods up to and exceeding 200 years. There is, however, no objective data or evidence that geomembranes will perform according to initial design standards and requirements for the 200 to 1,000 year design life of an UMTRA Project pile. Therefore, we were forced to conclude that geomembranes cannot be incorporated into disposal cell covers as permanent infiltration barriers.

#### 3.3 ALTERNATE COVER MATERIALS

The materials listed in Table 3.1 were considered and evaluated as alternate materials for use in UMTRA Project disposal cells as infiltration barriers. The materials were evaluated on the basis of longevity, performance, constructibility, and cost. As shown in the table, only catalytic airblown asphalt and CLAYMAX<sup>R</sup>, a bentonite layer between two geotextiles, have hydraulic conductivities lower than low permeability compacted soils (possibly amended with bentonite).

None of the materials evaluated has proven longevity. The operative element of CLAYMAX is, however, bentonite, which is a natural clay that is unlikely to change in the environments encountered in the covers of UMTRA Project piles. Thus attention was concentrated on CLAYMAX. It is easy to install and relatively inexpensive, as shown on Table 3.1. For these reasons the material was recommended as a potential infiltration barrier on disposal cell covers.



Table 3.1 Alternate Cover Materials<sup>a</sup>

Material	Performance	Longevity	Constructibility	Installed cost (\$)
Catalytic airblown asphalt	$K = 10^{-9}$ cm/s	Withstood aging test equivalent to seven years	Applied with a spray bar system	2.60/m <sup>2</sup> <sup>b</sup>
Asphalt-rubber admixture	$K = 10^{-7}$ to $10^{-10}$ cm/s	Used past 18 years on highways and leaching pads	Applied with a spray bar system	3.35/m <sup>2</sup> <sup>c</sup>
Hydraulic asphalt concrete	Erosion control $K = 10^{-8}$ cm/s	Used on highways since the early 1950's	Hot mix paver	9.20/m <sup>2</sup> <sup>d</sup>
Asphalt emulsion admixture	$K = 10^{-5}$ cm/s	Ongoing field test at Grand Junction, CO, since 1980	Cold mix paver	23.20/m <sup>2</sup> <sup>e</sup>
Fabriform Rayvetmat <sup>R</sup>	Low permeability erosion control	Used past 20 years on reservoirs. Susceptible to cracking due to settlement and freeze/thaw cycling	Grout injected into pre-fab panels	13.50/m <sup>2</sup> <sup>f</sup>
Fiber reinforced gunite	Low permeability erosion control	Used past 20 years on canal linings and embankments. Susceptible to cracking due to freeze/thaw cycles and settlements	Applied with a spray gun	13.50/m <sup>2</sup> <sup>g</sup>
Latex modified concrete	Low permeability erosion control	Used past 30 years on bridge and parking decks	Applied like ordinary portland cement	30.00/m <sup>2</sup> <sup>h</sup>
Claymax <sup>R</sup>	$K = 10^{-9}$ cm/s	Used on landfill covers since March, 1986	Rolled out into place, no fasteners required	6.20/m <sup>2</sup>

<sup>a</sup> cm/s = centimeters per second; m<sup>2</sup> = square meters; K = hydraulic conductivity.

<sup>b</sup> Cost assumes field thickness of 0.9 cm (1983 cost).

<sup>c</sup> Cost assumes field thickness of 0.6 cm and includes MC250 primer coat (1988 cost).

<sup>d</sup> Cost assumes field thickness of 10 cm (1983 cost).

<sup>e</sup> Cost assumes field thickness of 6 cm (1981 cost).

<sup>f</sup> Cost assumes field thickness of 10 cm (1988 cost).

<sup>g</sup> Cost assumes field thickness of 8 cm and includes 10" x 10" wire mesh reinforcement (1988 cost).

<sup>h</sup> Cost assumes field thickness of 10 cm (1988 cost).

It is important to note that the bentonite in the CLAYMAX is the infiltration barrier element. The geotextiles are there to facilitate transport and installation. They will deteriorate with time, and cannot be relied on as a permanent design element of a cover.

In theory, although it might be somewhat difficult to construct, a layer of bentonite could be incorporated into the cover by (a) placing on the radon barrier a geotextile, (b) spreading a layer of bentonite about two to six inches thick, (c) placing a second geotextile, and (d) covering carefully with the drain. Such an approach could become necessary either because CLAYMAX becomes expensive, or because a greater thickness of bentonite is required to control the increased flux that might result due to the build up of water above the infiltration barrier that is necessary to sustain lateral flow in the drain.

### 3.4 ALTERNATE COVER DESIGNS

In this study, the following alternate cover designs or cover component design enhancements were evaluated, and accepted or rejected for the reasons noted:

- o Rock/soil matrix: The top cover component would be a mixture of soil and rock; the rock to control erosion, and the soil to support vegetation, which improves evapotranspiration, thus reducing infiltration. In order to function adequately as an erosion barrier the rock particles should be in particle-to-particle contact. Therefore, at least 70 percent of the layer would have to be rock. Conversely, to support an adequate vegetation community about 70 percent of the layer would have to be soil. Because of this grading incompatibility, the proposal for a rock/soil matrix was rejected.
- o Corrugated cover: Figure 3.1 shows the details of a corrugated cover. It incorporates a series of troughs and ridges parallel to the slope of the cover. The aim is to shed water off the steep slopes of the ridges as rapidly as possible, thereby reducing infiltration. By leading the runoff into the troughs and concentrating flow off the pile in rock drains at the nadir of the trough, the potential infiltration is further reduced. The performance of such a cover was evaluated with the computer code SOILMOIST, which analyzes flow off and through covers such as that shown in Figure 2.1. The model predicted that the travel time down the ridges is fast enough to result in partially saturated flow through the infiltration barrier; about sixty percent of the total pile top surface was thus subject to the reduced infiltration associated with partially saturated flow. By contrast, the trough

lengths and geometry in a typical pile are likely to be such that travel time and water residence time are on the order of several days, so saturated flow conditions are predicted. The weighted average flux through the troughs and ridges still yields more infiltration than is acceptable in complying with EPA groundwater standards at a typical UMTRA Project site, and so corrugated covers have not been further analyzed.

- o High permeability drain: The primary benefit of increasing the hydraulic conductivity of the drain above that of the radon/infiltration barrier is the decrease in residence time of the precipitation runoff, and hence the reduced infiltration through the infiltration barrier. Other ways to increase the runoff rate are to increase the top slope and decrease the slope length. The topslope and the slope length cannot be varied, for a practical pile geometry, by more than a factor of two to three. By comparison, the hydraulic conductivity of a drain material can readily be increased one or more orders of magnitude simply by selecting the right sand--a clean sand to fine gravel. Computer runs with the code SOILMOIST show that increasing the hydraulic conductivity of the drain is an efficient way to reduce infiltration. For this reason a high permeability drain has been adopted at certain sites (see later section for details).
- o Capillary break: Figures 3.2 and 3.3 show two configurations in which a capillary break may be used in the cover of a disposal cell to limit infiltration. A capillary break operates in the following way: water will not seep downward from fine to coarser-grained material if the relative gradation of the two materials, and in particular the fine gradation of the overlying material, is sufficient to sustain negative water pressures. The system fails when the overlying material becomes saturated and the water pressure becomes positive. Field tests show that lateral flow can occur for about 25 feet at a slope of about ten percent before the overlying soil saturates and breakthrough occurs. Because of the limited length of efficacy of a capillary break, the configuration shown in Figure 3.3 is not feasible for UMTRA Project piles. Use of a capillary break with a corrugated cover was accordingly considered. This system, however, is characterized by the same disadvantages as a conventional corrugated cover, and is therefore unlikely to find much use on the UMTRA Project.
- o Freeze/thaw: In this special study the effect of repeated freezing and thawing on the hydraulic conductivity of the soil of a saturated infiltration barrier was measured. Generally two to four cycles of freezing and thawing will increase the hydraulic conductivity of a saturated clay soil by one to two orders of magnitude. As this increase in hydraulic conductivity will be unacceptable at most UMTRA Project piles, the decision has been made to place all potentially saturated infiltration barriers beneath the depth of predicted frost penetration. A computer code to calculate site-specific frost penetration depths has been created. No tests to quantify the effect, if any, of freezing and thawing on partially



saturated soils have been done. We consider that the effect will be small but the cumulative effect over 1,000 years of repeated freezing and thawing of a partially saturated soil could affect the partially saturated hydraulic conductivity of an infiltration barrier. The magnitude of the effect will depend on the number of cycles of freezing and thawing, the moisture content at freezing, and the soil gradation.

- o Vegetated covers: Vegetation has established naturally on the Shiprock, New Mexico, pile, even though vegetation was not a planned part of the remedial action. We may conclude that vegetation will establish naturally on most UMTRA Project piles in moderate climates, even through thick (up to 18 inches) rock erosion barriers. It is well known that vegetation enhances evapotranspiration; therefore, it is reasonable to utilize this beneficial aspect of vegetation to reduce potential infiltration to a pile. As described above, a thick layer of random material is required to protect the infiltration barrier against the effects of freezing and thawing; this layer can double as a soil to support vegetation. In the special study on vegetation we considered the appropriate design procedures for the use of soil and vegetation; as the decision has been made to use vegetation at a number of UMTRA Project piles to limit infiltration, the design of covers incorporating vegetation is discussed in greater detail in a later section.
- o Radon barrier moisture content: The radon/infiltration barrier at three sites (Canonsburg, Shiprock, and Clive) has been instrumented and the actual in situ moisture contents of the infiltration barriers have been measured. Data indicate that the moisture contents are at or close to the placement compaction moisture content. This gives rise to an hypothesis that the infiltration barrier is likely to remain partially saturated in the future, at least in climates such as those at sites where measurements have been taken.



SLOPE BREAK:  
TOP TO SIDE

CREST OF  
CORRUGATION

NADIR OF  
CORRUGATION

SCHEMATIC OF TOP OF RADON BARRIER  
FOR CORRUGATED COVER

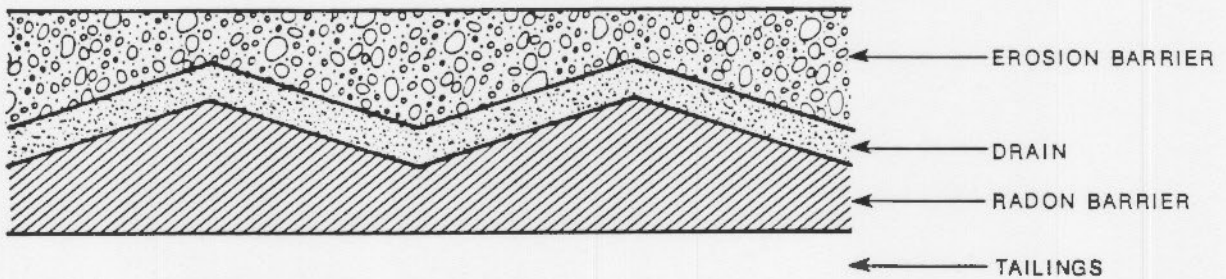
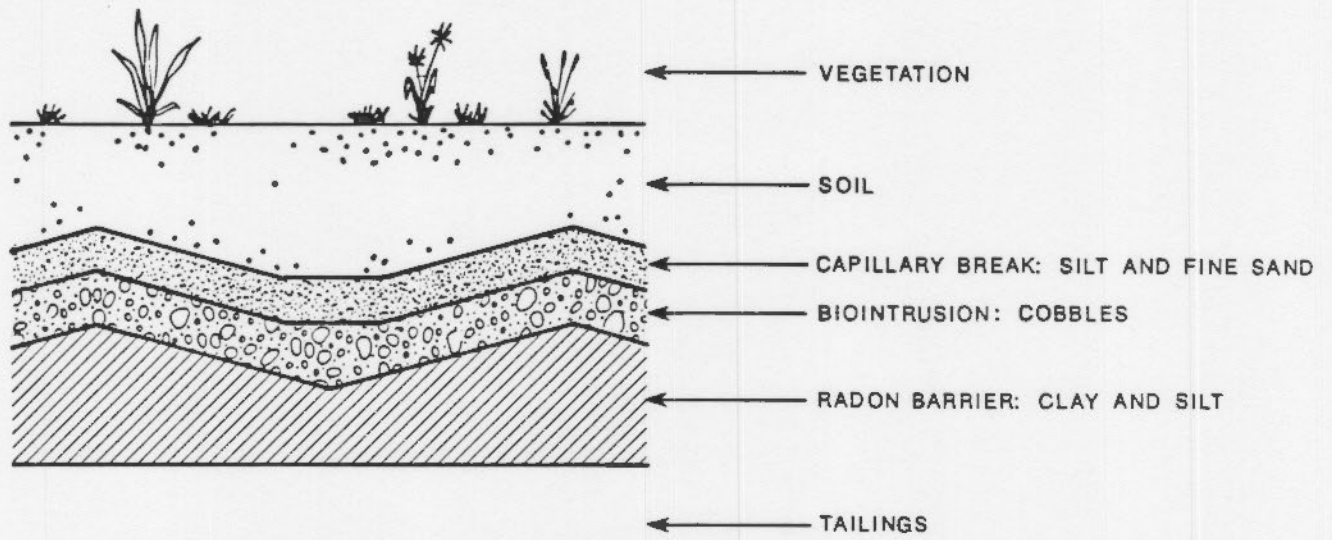
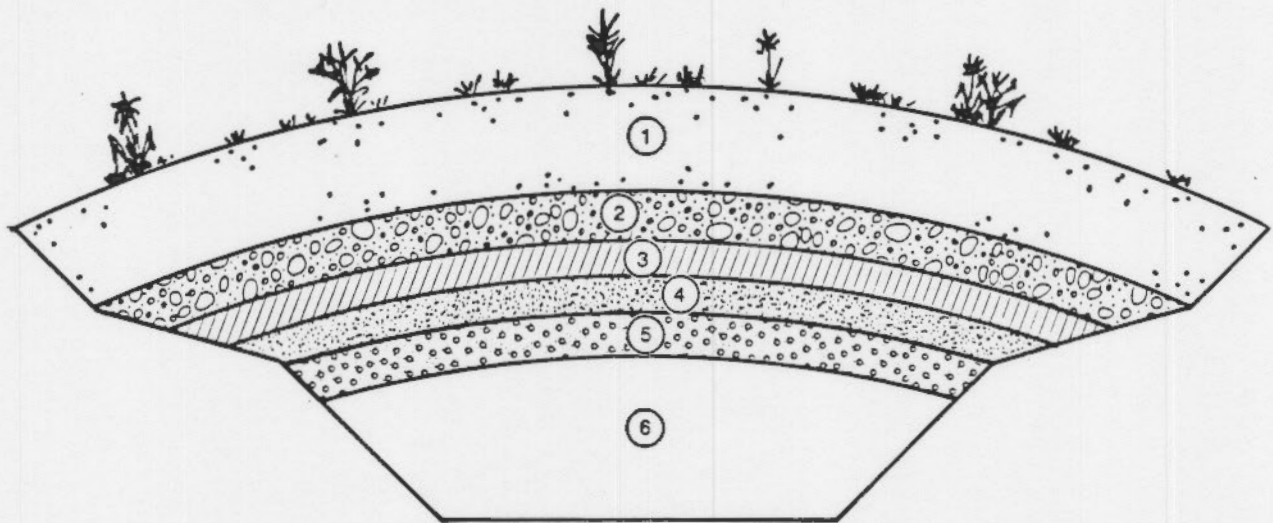

FIGURE 3.1  
THE CORRUGATED COVER



**FIGURE 3.2**  
**CAPILLARY BREAK WITH CORRUGATED COVER**



- ① SOIL AND VEGETATION
- ② DRAIN: COBBLES
- ③ INFILTRATION BARRIER: CLAY
- ④ CAPILLARY BREAK: SILT & FINE SAND
- ⑤ CAPILLARY BREAK: GRAVEL
- ⑥ ENCAPSULATED MATERIALS

**FIGURE 3.3**  
**CAPILLARY BREAK OVER NARROW DISPOSAL TRENCH**

#### 4.0 ALTERNATIVE DISPOSAL CELL DESIGN APPROACHES

The EPA standards applicable to the design of UMTRA Project disposal cells and remedial action works establish, in brief, the following design criteria:

- o A design life of 1,000 years to the extent achievable, and at any rate of 200 years.
- o Control of the dispersion of the tailings and contaminated materials and prevention of their use by humans and animals.
- o Minimum reliance on active human maintenance.
- o Control of seepage of contaminants from the disposal facility to the extent required to achieve compliance with the groundwater standards.

In order to design a disposal cell and its cover to lead to compliance with the groundwater standards, consideration must be given to the following two planning philosophies:

- o The remedial action groundwater compliance strategy. Some strategies are to design the disposal cell to limit contaminant release so that the EPA Maximum Concentration Limits are achieved at the point of compliance; to incorporate into the disposal cell design reasonable details and features to reduce contaminant seepage release to levels as low as reasonably achievable, and hence invoke and justify ACLs; and to establish that the existing groundwater at the site justifies supplemental standards, and hence design a disposal cell that limits contaminant seepage to levels as low as is reasonably achievable in the circumstances.

- o Infiltration estimation approach. Some infiltration estimation approaches, and the corresponding cover designs are to:

Recreate natural conditions--hence infiltration and seepage will not change current conditions. Cover to consist of same materials as currently on the site.

- o Assume saturated flow through infiltration barrier--thus probably overestimate seepage. Use very low permeability layers protected from freeze/thaw.
- o Assume or prove partially saturated flow--realistic, but difficult to prove. Standard cover with little impetus to protect infiltration barrier from freeze/thaw.

Once the disposal cell design has been formulated and a compliance strategy formulated, a performance evaluation is undertaken and documented for presentation to the Nuclear Regulatory Commission (NRC). The essential part of the performance evaluation is a written explanation and substantiation of why the disposal cell will perform as designed and, in particular, will comply with the EPA standards for longevity, stability, groundwater impact, and minimal maintenance.



## 5.0 THE CHECKLIST DESIGN APPROACH

At the same time as the studies described above were in progress, alternate cell and cover designs were being formulated and evaluated. Cell and cover design were reevaluated in response to both the findings of the studies and the pressures and demands associated with site-specific planning and input from reviewers and concurring agencies. The following section describes the general cell and cover designs and design selection approaches formulated; subsequent sections describe the practical implementation of these ideas and approaches.

The cell and cover designs described below are called Checklist Cells, Checklist Perimeter Dikes, and Checklist Covers. These titles are specifically chosen to indicate the true intent and purpose of the design details. They are not the "best." They are not "generic." It has been suggested that we call them the ALARA cell and cover. This is valid in the sense that if it is necessary to support ACLs and hence prove that the design complies with ALARA requirements, it would be necessary to examine the checklist details and substantiate why a particular component or detail is not adopted. However, calling them the ALARA cell and cover does not imply that they are the designs required for successfully invoking ALARA. They are simply those details that have emerged from the studies and site-specific discussions as being potentially suitable for use and incorporation in disposal cell designs that will lead to compliance with the proposed EPA groundwater standards. They are intended to constitute a list of possible cell and perimeter dike details and cover components that should be examined and considered when compiling, for a specific site, a disposal cell design. In preparing site-specific designs, site-specific factors must be taken into account. We believe that the checklist details are comprehensive enough to cover all situations likely to be encountered at UMTRA Project sites, but if site-specific factors dictate different details, other site-appropriate details should be adopted even though they are not to be found in the checklists.

Associated with the checklist cover design is a list of elimination criteria. Examples of cover component elimination criteria are provided in this paper. Thus the designer may, for each component in the checklist cover, scan the elimination criteria list. If one or more of the elimination criteria are applicable or appropriate to a site, then that particular cover component need not be used.

In practice, selection of the appropriate design should include those details that lead to the lowest achievable seepage, not necessarily because of the requirement inherent in the ACL approach to reach limits as low as reasonably achievable (ALARA), but simply because this is an approach consistent with good and prudent engineering practice.

As noted in an earlier section of this paper, the disposal cells at a number of sites had already been constructed or construction was in progress when the proposed EPA groundwater standards were issued. For those sites the checklist design approach is not absolutely applicable. The designer is

constrained by the reality of the current state of design or construction. It may, for example, be impossible to implement any of the perimeter dike details as a result of site size or cell layout constraints. The cover may have already been constructed or the materials produced. In such cases the checklist details serve only to confirm that the actual design as being constructed is reasonable. In certain cases, as described in the case histories, we have altered design details for sites at which construction is in progress. This was done on the basis of the ideas incorporated into the checklist approach.

An additional use of the checklist approach for sites at which design is far advanced or construction is in progress is to apply for ACLs. Such an application involves providing to the NRC documentation and rationale that the implemented and constructed design does achieve the desired end of ALARA concentration limits. By discussing potential applicable checklist details in the ACL application, and by showing that they are not appropriate or implementable, we believe we can, in a sound and convincing manner, demonstrate to reviewers that design decisions are correct and in compliance with the proposed standards, regardless of whether the compliance strategy is to use MCLs or ACLs.

## 6.0 CHECKLIST CELL DESIGNS

We have identified three basic cell designs that should be considered for an UMTRA project disposal cell. These are:

- o The conventional cell: Figure 2.1 shows the layout and details of the conventional cell. It involves simply placing an appropriate cover over the top and sides of the tailings and contaminated materials that have been reconfigured to form a suitable shape--usually a pyramid top and relatively flat (five to one) sides.
- o The constrained cell: As shown in Figure 6.1, the essential feature of such a cell is surrounding dikes of clean compacted material. This cell design is likely to be appropriate primarily for sites to which the tailings and contaminated materials are relocated. The advantage of this design is that there is no potential for seepage through contaminated material underlying the sideslopes. This may facilitate compliance with the EPA groundwater standards at sites where it is necessary to significantly or severely limit the quantity of contaminated seepage from the cell. The disadvantage is that this cell is likely to be the most expensive to construct; the clean material to build the perimeter dikes will be costly to obtain and place. Material for constructing the perimeter dikes may be obtained from an excavation formed before placement of the tailings. Determination of the optimum depth of excavation is based on the nature of the foundation materials and the impact of decreasing the distance between the tailings and the groundwater table. In order to preclude the possibility of backflow of water flowing off the cover over and through the perimeter dikes and hence into the tailings, it will be necessary to either provide an in-cell slope to the dike or to build into the dike anisotropy such that flow is out and away from the tailings and other contaminated materials. The top cover slope and details will be selected by considering the checklist cover described later.
- o The buttressed cell: As shown in Figure 6.2, this cell involves buttressing the sideslopes of the in situ tailings pile with clean compacted material to provide stability. This cell design is likely to be appropriate where tailings are stabilized in place. If the tailings are to be relocated, the design may be adopted in order to maximize the cell volume for tailings and contaminated materials. The major constraint on the use of this cell is the need to position the bentonite layer relative to the clean material buttress to provide slope stability. Hydrological calculations should be performed to confirm that infiltration through the low-permeability sideslope layer can be limited to acceptable amounts by placing a drain over the low-permeability element or by the impedance to flow resulting from the presence of the bentonite layer. The topslope cover is selected by considering the checklist cover.



Many Title II uranium mill tailings piles are surrounded by earthen dikes or embankments. As noted by Shepherd and Abt (1988), this is the most significant difference between Title I and Title II piles. As described by Miller and Davis (1987), the NRC has accepted for the Ray Point, Texas, Title II site a soil cover for the disposal cell. Soil has been used in the remedial action works on both the top and sideslopes. The two most significant design features of the Ray Point pile are shown schematically in Figure 6.3. The top surface is contoured so that all flow is directed away from the steeper sideslopes (not towards and over them as is current UMTRA Project practice). Flow is directed to a broad shallow swale or topographic low, and flow from the top of the pile to the surrounding area is gentle. If required, erosion control rock may be placed or base-level features may be constructed in the drainage swale. The NRC has compiled a description of acceptable analytical techniques to assess the performance and substantiate the acceptability of pile layouts such as shown in Figure 6.3. In brief, the designer must show that the precipitation that will fall on the perimeter dike will not cause so deep a gully that it will erode towards the tailings (see Figure 6.4). Also the designer must show that flow on the topslopes and in the ultimate swale will not cause gully erosion that will impinge into the tailings.

Two other disposal cell layouts may also be considered. The first of these is that adopted for the Monument Valley tailings, i.e., relocate them and place them on top of another pile. A similar approach is being used at the Riverton, Wyoming, site, although there the reason was not the proposed EPA groundwater standards. The obvious advantage of colocation is the presence of one rather than two piles, particularly if groundwater conditions at the colocation site are conducive to standards compliance. Although there are two UMTRA Project sites at which colocation could be used (Falls City and Ambrosia Lake), this option is unlikely to be used again on the UMTRA Project.

The second possible disposal cell layout listed for completeness is termed the "cigar pile." The tailings and other contaminated materials would be placed into a long narrow pile oriented perpendicular to the prevailing groundwater flow gradient. In theory, the potential for meeting MCLs is enhanced because the impact of contaminant seepage from the pile is spread over a greater distance and diluted by a greater volume of groundwater seeping beneath the pile. Another advantage of this cell is the relatively short sideslopes which can be kept steep to increase the rate at which the pile sheds precipitation and thus minimize infiltration. Difficulties in implementing this type of pile include precise definition of the prevailing groundwater flow gradient; uniformity of the groundwater flow gradient over the length of the pile; the increased volume of cover relative to the encapsulated volume; and the absence of topslope where very low-permeability elements may be used.



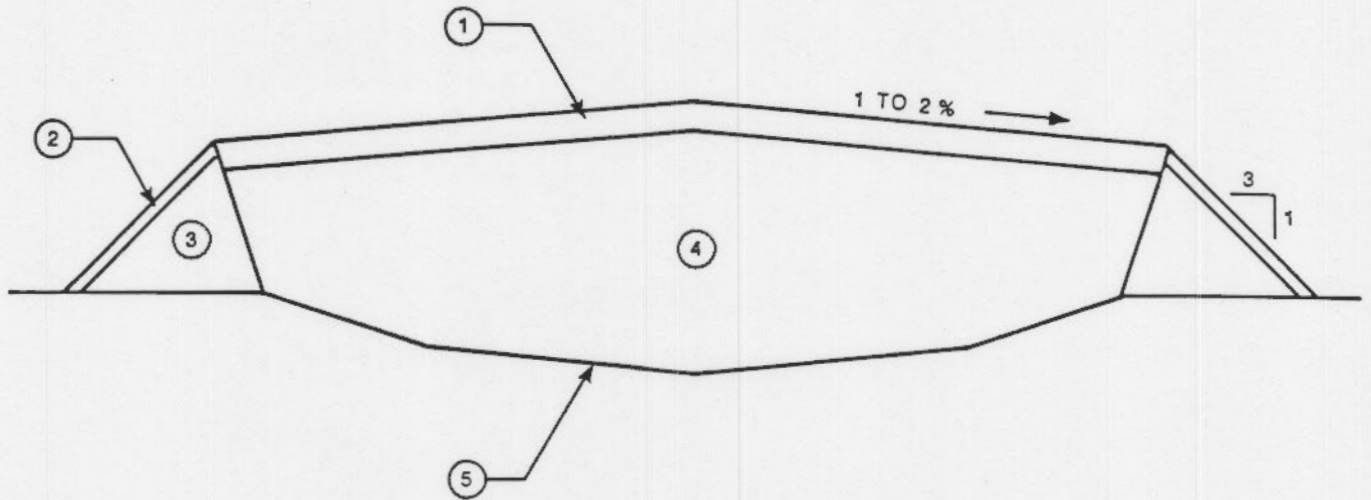

- ① TOP COVER: SEE FIGURE 3
- ② SIDE COVER: EROSION RESISTANT ROCK
- ③ PERIMETER DIKE: COMPACTED SOIL & ROCK
- ④ DISPOSAL CELL: TAILINGS & CONTAMINATED MATERIAL
- ⑤ BASE: EXCAVATED SOIL

**FIGURE 6.1**  
**"CHECKLIST"**  
**CELL FOR RELOCATION OPTION**

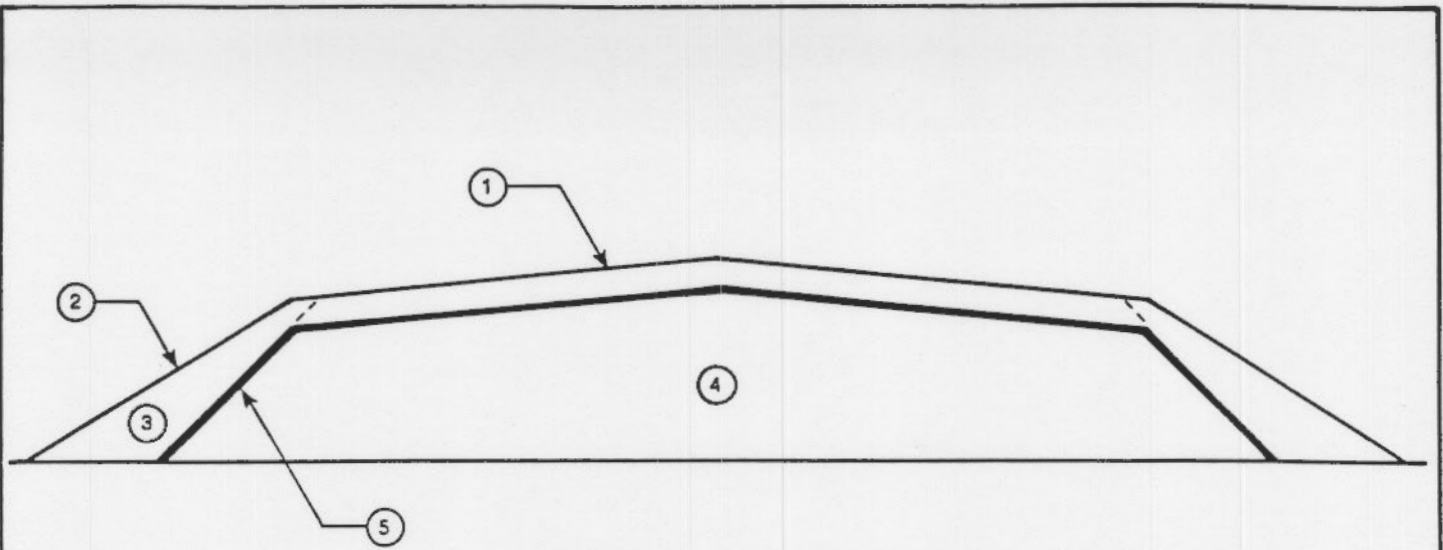

- ① TOP COVER: SEE FIGURE 3
- ② SIDE COVER: EROSION RESISTANT ROCK
- ③ PERIMETER BERM OR DIKE: CLEAN FILL
- ④ DISPOSAL CELL: TAILINGS & CONTAMINATED MATERIAL
- ⑤ SIDE AND TOP INFILTRATION BARRIER: COMPACTED CLAY, CLAYMAX, GEOMEMBRANE, DRAIN, OR OTHER

**FIGURE 6.2**  
**"CHECKLIST"**  
**CELL: IN SITU OPTION**

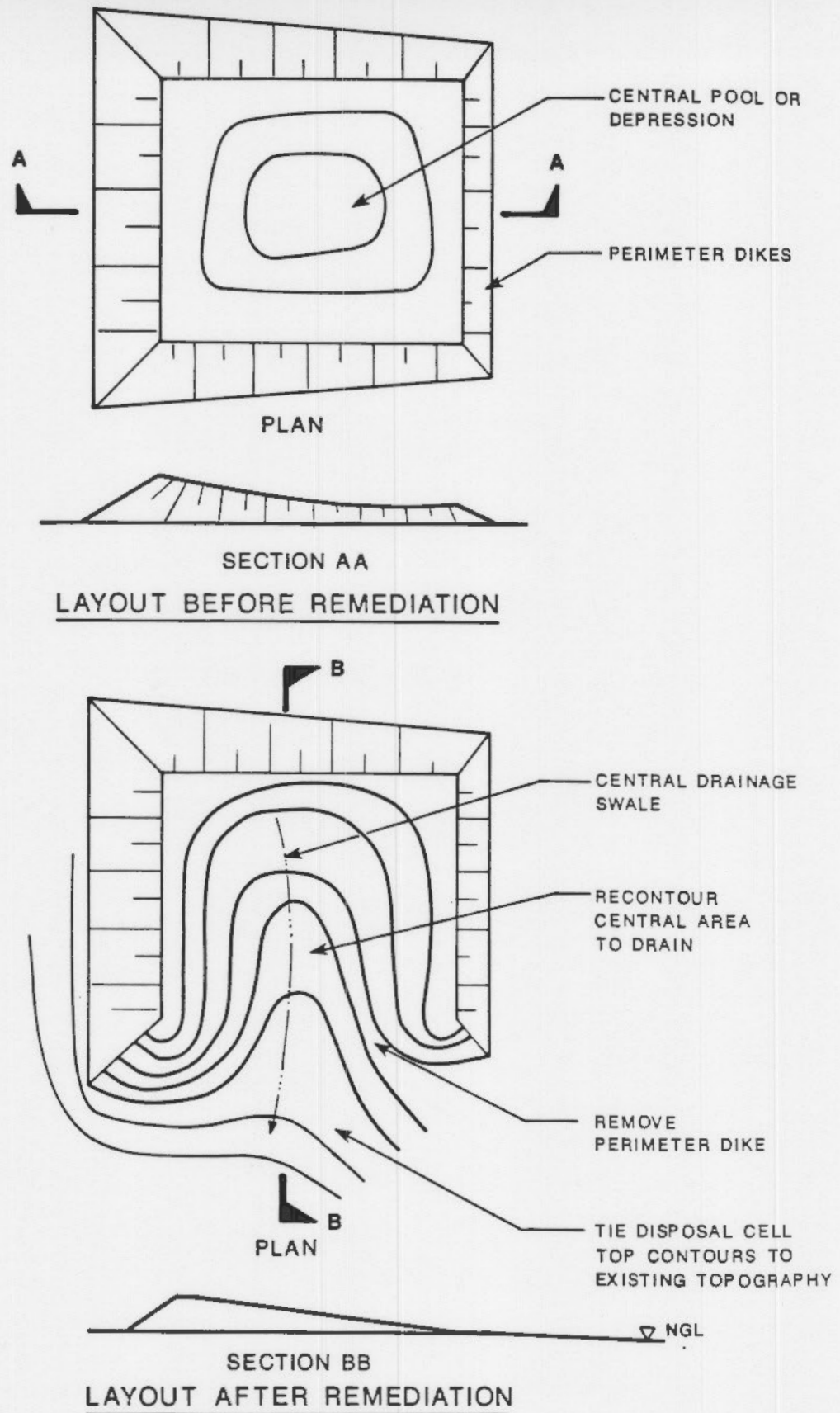

**FIGURE 6.3**  
**PERIMETER DIKE REMOVAL DISPOSAL CELL LAYOUT**

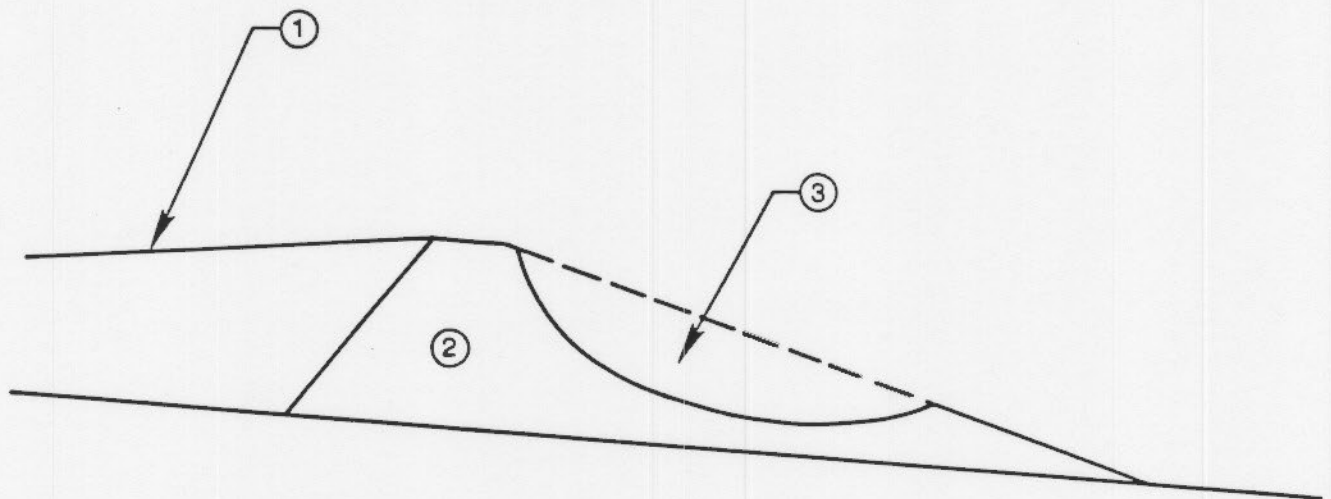

- ① TOPSLOPE - GRADE TO DRAIN AWAY FROM PERIMETER DIKE
- ② PERIMETER DIKE OF UNCONTAMINATED MATERIAL
- ③ MAXIMUM CALCULATED GULLY DEVELOPMENT

**FIGURE 6.4**  
**PERIMETER DIKE EROSION ASSESSMENT**



## 7.0 CHECKLIST APPROACH TO PERIMETER DIKE DETAIL

Figure 7.1 shows a number of possible designs for the perimeter dikes. To determine the appropriate detail, proceed as follows:

- o Examine possible side dike profiles as shown on the figure.
- o Evaluate potential for use at given site.
- o Adopt appropriate design details.

STABILIZE IN PLACE

RELOCATE

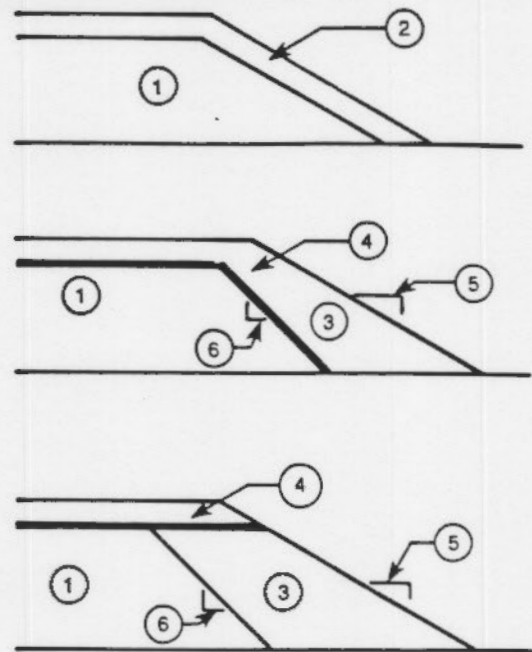
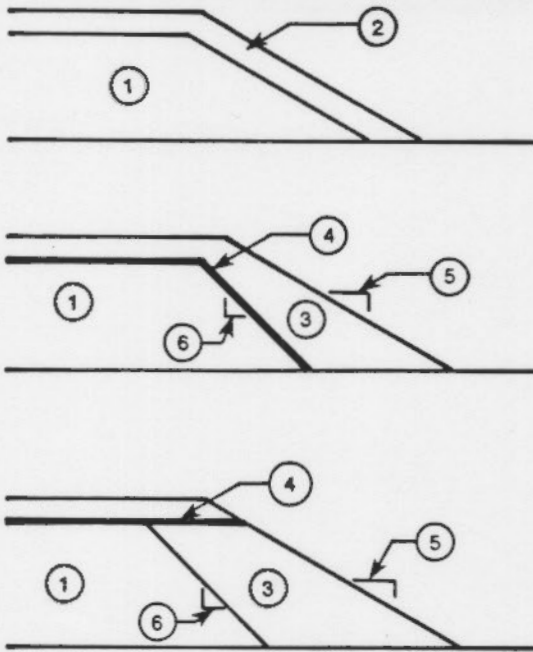

- ① TAILINGS & CONTAMINATED MATERIAL
- ② COVER: RADON BARRIER, INFILTRATION BARRIER, EROSION PROTECTION
- ③ PERIMETER DIKE: CLEAN FILL
- ④ INFILTRATION BARRIER: BENTONITE, CLAYMAX, GEOMEMBRANE
- ⑤ SIDESLOPE: SELECT FOR STABILITY
- ⑥ INNER SLOPE: OPTIMIZE
- ⑦ BELOW GRADE FILL ZONE: USE EXCAVATED SOIL IN PERIMETER DIKE

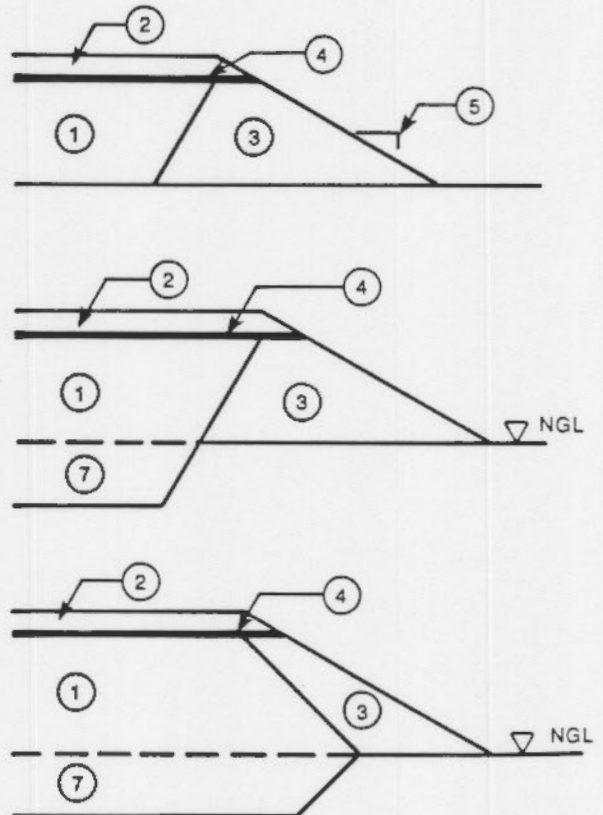

**FIGURE 7.1  
"CHECKLIST"  
PERIMETER DIKE ALTERNATES**

## 8.0 THE CHECKLIST COVER

The Checklist Cover as shown on Figure 8.1 incorporates all reasonable components possibly required at a site to:

- o Control erosion.
- o Limit infiltration.
- o Provide freeze/thaw protection.
- o Inhibit radon emanation.
- o Drain or shed precipitation.
- o Control biointrusion.

In order to determine the appropriate components to be incorporated into the cover at a particular site, proceed as follows:

- o Obtain site-specific data.
- o Examine Checklist Cover and eliminate components on the basis of criteria in the Component Elimination Criteria List in attachment A.
- o Compile final cover as a composite of the remaining, non-eliminated components.

The checklist approach to the design of a cover is simplistic in that each component tends to be viewed in and of itself. In reality, there is considerable interaction of the various components. It has been said that the various components, properly selected, form a functional symbiotic entity. For example, in theory the use of CLAYMAX as the only operational infiltration barrier is reasonable. However, demands such as stability constraints dictate relatively flat slopes for the bentonite layer. Thus there is little gravity-induced runoff or shedding of precipitation through the drain above the bentonite layer. An hydraulic head could build up above the thin bentonite layer; the result would be an increased gradient and hence increased infiltration through the infiltration barrier. To reduce the potential for build up of water in the drain it is prudent to place a soil layer (probably required at any rate for frost protection) above the infiltration barrier, and to establish vegetation in the soil. The evapotranspiration of the vegetation will reduce the frequency and the amount of percolation reaching the drain, hence the need to rely on lateral shedding to remove water from the pile. The designer should always be on the lookout for possible opportunities to enhance the interactive or symbiotic effect of the various components in a cover.

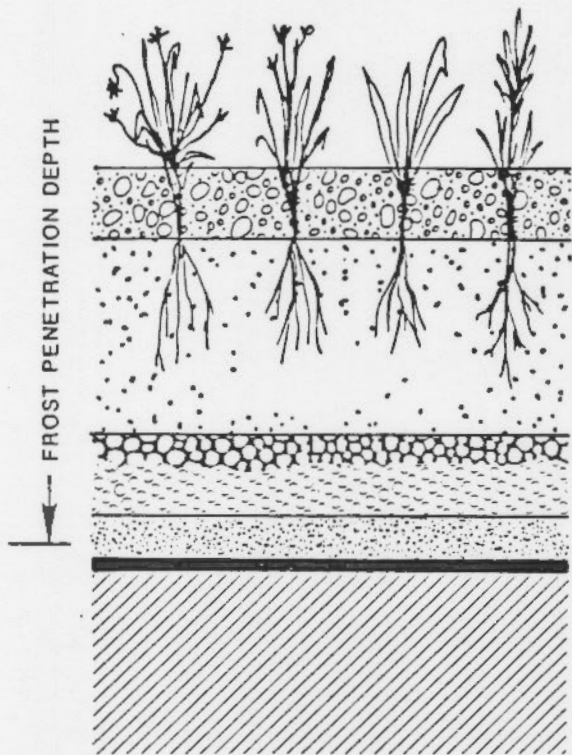

- VEGETATION
- 0 - 1.0' ROCK MULCH
- 3.0' GROWTH MEDIUM & FROST PROTECTION
- 1.0' BIOBARRIER: COBBLES (TOP CHOKED OR FILTERED)
- 0.5' DRAIN: CLEAN SAND  
INFILTRATION BARRIER: CLAYMAX
- 1.0' RADON BARRIER: CLAY/SILT

**FIGURE 8.1  
"CHECKLIST"  
TOP COVER**



## 9.0 TECHNICAL APPROACH TO THE USE OF CLAYMAX

The infiltration barrier can be one or more of the following:

- o A low permeability soil that also functions as the radon barrier.
- o A soil amended with bentonite; this infiltration barrier also functions as the radon barrier.
- o A layer of bentonite about two to six inches thick.
- o A CLAYMAX mat (or geosynthetic), which is a commercial product that consists of a thin (0.25 inch dry, 1.0 inch hydrated) layer of bentonite between two geotextiles.

Some technical details about CLAYMAX are:

- o Hydraulic conductivity of about  $1 \times 10^{-9}$  centimeters per second (cm/s). The manufacturers of CLAYMAX claim an hydraulic conductivity of less than  $1 \times 10^{-9}$  cm/s. Mitchell (1976) gives the hydraulic conductivity of bentonite as ranging from  $1 \times 10^{-8}$  to  $1 \times 10^{-9}$  cm/s. Test done by the Technical Assistance Contractor (TAC) on the UMTRA Project confirm the low hydraulic conductivity of the bentonite.
- o An effective angle of friction that varies from four to 10 degrees. This strength range is taken from data in Mitchell (1976) for bentonite. Tests by the TAC confirm this strength range. The manufacturers of CLAYMAX quote a much higher strength, but we consider their data nonrepresentative of failure through the bentonite layer.
- o Bentonite is a natural material; it is not expected to alter during the disposal cell design life.
- o Easy installation. Joining is achieved by overlapping successive panels by about six inches.
- o The geotextiles are not long-term elements of the mat; they will deteriorate and should not be relied on as a functional part of the cover. Their purpose is to facilitate transport and placement of the mat.

The following are some design details for the use and construction of covers that include CLAYMAX as the operative infiltration barrier (see also Figures 9.1 and 9.2).

- o Place above the radon barrier. The mat is placed above the radon barrier because the fine-grained soils of the barrier make an ideal bedding layer. The mat should not be placed within the radon barrier because the permeability of the soils of the radon barrier are such that drainage is not facilitated and hence an hydraulic head could build up above the mat and increase the water flux through the mat. The radon barrier should be sloped at at least two percent so that precipitation entering the drain above the mat can flow off the pile.

- o Cover with a filter (or drain). The particle gradation should be primarily a clean sand. The hydraulic conductivity should preferably be no less than 0.1 cm/s. The drain thickness should be about six inches. The purpose of the drain is to preclude the build up of an hydraulic head on the bentonite; water will flow downslope through the drain and off the pile, and will not accumulate above the mat and increase the hydraulic gradient through the bentonite.
- o Place beneath depth of freeze/thaw. Data to prove that the bentonite is not affected by freezing and thawing is not currently available. Until data to prove no reduction in hydraulic conductivity with repeated freezing and thawing becomes available, the conservative approach of placing material beneath the predicted depth of frost penetration should be adopted.
- o Do not use on unbuttressed sideslopes. Bentonite is a very low strength material and should be used with extreme caution on sideslopes. The buttress detail shown on Figure 9.2 may be adopted if slope stability analyses confirm adequate factors of safety against sliding, deformation, or other instability.
- o The factor of safety of an infinite slope of 4.5 percent that incorporates a material with an angle of friction of four degrees is 1.5. To maintain static stability, 4.5 percent is therefore the maximum topslope inclination that should be used unless more detailed analyses are completed to demonstrate stability. For dynamic, or earthquake loading conditions, a pseudostatic analysis using the site design acceleration should be completed to confirm that the topslope will remain stable.

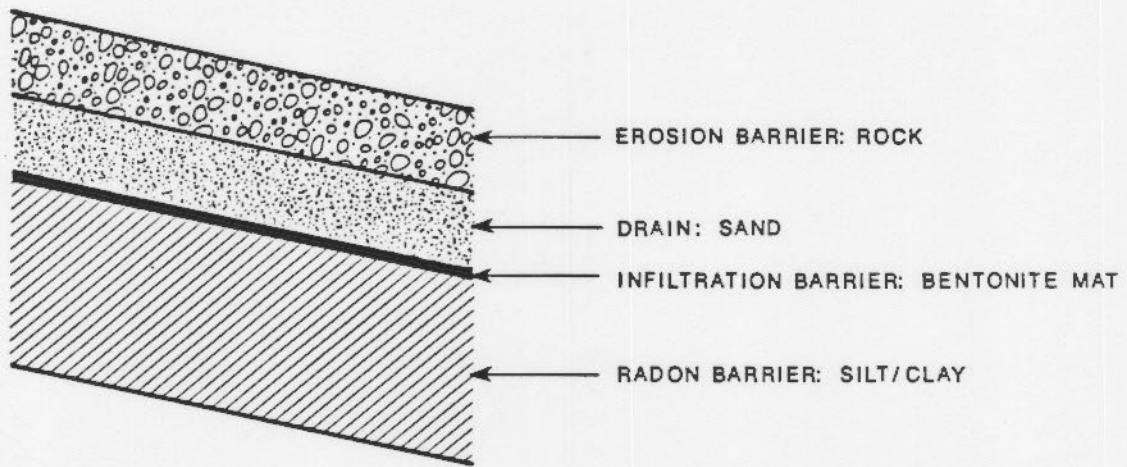

EXAMPLE I

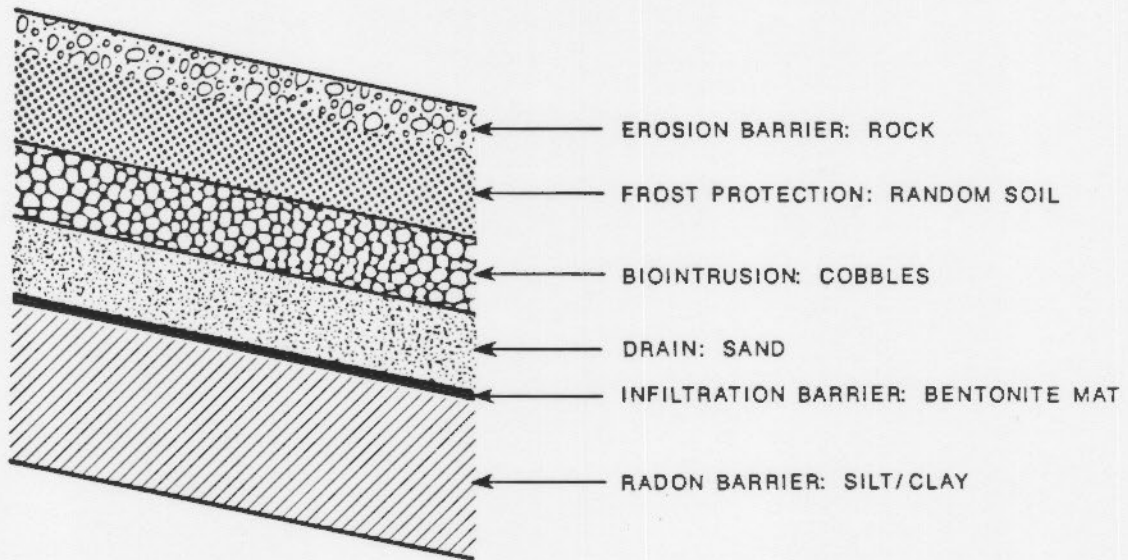

EXAMPLE II

**FIGURE 9.1  
POSITION OF BENTONITE MAT INFILTRATION BARRIER  
IN UMTRA COVERS**



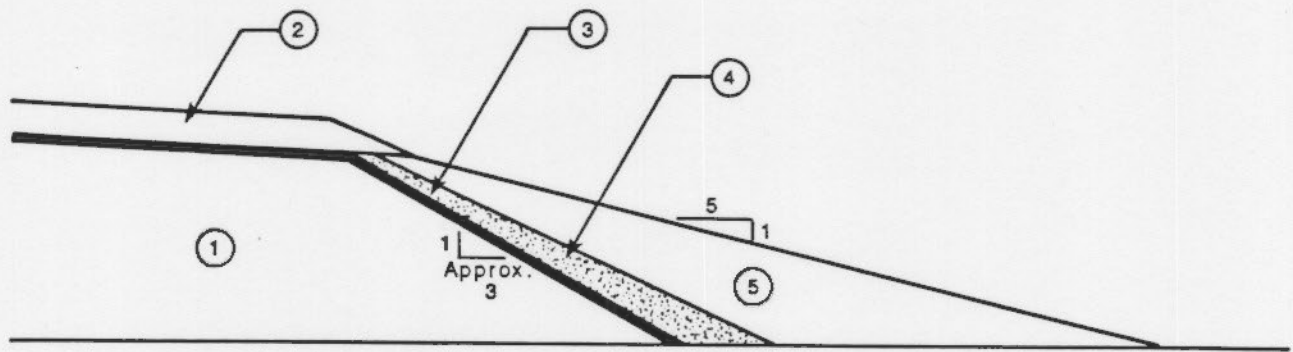

- ① ENCAPSULATED MATERIALS: TAILINGS
- ② CELL COVER
- ③ SIDESLOPE INFILTRATION BARRIER: BENTONITE MAT
- ④ SIDESLOPE DRAIN: SAND
- ⑤ SIDESLOPE DIKE OR BERM: CLEAN FILL

**FIGURE 9.2**  
**BENTONITE MAT INFILTRATION BARRIER**  
**ON CELL SIDESLOPES**

## 10.0 TECHNICAL APPROACH TO THE DESIGN OF SOIL COVERS

Vegetation has established naturally on the Shiprock, New Mexico, pile. The cover design at that site is a seven foot radon barrier of compacted soil, six inches of relatively low-permeability bedding sand, and one foot of rock that constitutes the erosion barrier. Vegetation is not a planned part of the remedial action. More vegetation occurs on the sideslopes than the topslopes; the sideslope vegetation is typically tumbleweeds (Russian thistle and summer cypress). On the topslope are a number of salt cedars. The moisture content of the bedding material is relatively high; in places it is saturated. In contrast, the radon/infiltration barrier has a moisture content very similar to that at which the material was placed during construction. The appearance of the vegetation on the Shiprock pile, which is in an arid region, leads to the conclusion that there is a significant likelihood that vegetation will establish naturally on piles even through thick erosion protection rock layers. (Vegetation of significance has not appeared on the Clive, Utah pile. This may be due to the use of high salinity water in placement of the radon barrier.)

At many UMTRA Project piles, relatively thick layers of random soil are required to protect the infiltration barrier against frost. This layer is an ideal growth medium for vegetation. Because the piles provide a place for the vegetation to grow in a controlled way, and because we realize vegetation will grow on these piles, we have adopted vegetation as part of the stabilization approach.

Another reason for using vegetation on the topslopes of piles is its effect in reducing infiltration. Evapotranspiration will significantly reduce the amount of water that percolates through the soil layer to the underlying drains above the infiltration barrier. Hence there is a considerably reduced need to rely on the capacity of the drain to carry percolating water off the pile; there is a considerably reduced potential for the build up of an hydraulic head in the drain above a thin bentonite layer, and therefore a reduced potential for infiltration.

For the above reasons there has been a strong movement towards using vegetation on selected pile topslopes. The remainder of this section accordingly discusses the technical approaches to the engineering design of soil and vegetated covers.

The NRC has established the following methods as technical approaches for justifying or designing soil covers and slopes:

- o Compile a detailed geomorphological study of the site vicinity to establish the relationship between watershed area, runoff rates, vegetation, slopes, and gully development.
- o Demonstrate by a mathematical analysis that a gully on a given slope will not, as a result of the average annual precipitation, intrude into the tailings.
- o Determine, using a mathematical calculation, the slope length required to develop a gully for a given slope inclination.

- o Calculate the potential soil loss due to sheet flow erosion.
- o Compile an empirical evaluation of the potential for the formation of deep gullies on soil sideslopes and soil dikes, with the objective of precluding deepening of the gully through the soil into the tailings.
- o Undertake a rigorous cost/benefit comparison between the use of rock and soil covers in enhancing pile erosion protection.

Not all of the above approaches need be used at a particular site. It is left to the discretion of the designer to decide which one or combination of the above approaches are required for a site to provide to the NRC the required level of proof or certainty that the soil cover will remain stable.

The TAC/DOE recommends for consideration the following additional methods for justifying or designing soil covers:

- o Incorporate features into the design that establish erosion base levels or that preclude gully development or propagation of gullies (see Figures 10.1 and 10.2).
- o Use an acceptable analysis to calculate the required depth of soil to provide enhanced moisture retention and minimization of seepage to the filter above the bentonite infiltration barrier.

The technical approach of incorporating erosion control features into the topslope cover should be used only when it is not possible to show by site and regional geomorphic studies and the other mathematical analyses discussed above that gullies will not develop, or that if they do develop, they will not lead to unacceptable consequences. The reason for avoiding such erosion base level features, if possible, is that they will inevitably involve additional cost, and certainly a cost in excess of the cost of detailed geomorphological and engineering studies. For one UMTRA Project site for which such features have been considered, the potential additional cost is \$150,000.

There are a number of variations or details for erosion control features. The most critical design detail is the perimeter crest arrangement. This is the final erosion base level control feature for the pile topslope. In general, it may be argued that no gully will develop or extend below the horizontal line established by the crest elevation of the perimeter dike rock. If the horizontal line intersects the radon/infiltration barrier within a distance from the cell crest that provides sufficient runoff for gully formation, then the designer should consider the likely affect of flow from such a gully. Water from the gully may be anticipated to spread out from the gully and flow as "concentrated" sheet-flow over the crest and hence the pile sideslopes. The size of the erosion control rock on the sideslope should be adequate to prevent erosion by the concentrated sheetflow. If rocks of adequate size are not reasonably available, the designer should consider either raising the elevation of the crest dike in order to create a greater spreading distance, or intermediate erosion base level dikes should be included in the topslope details. The



spacing of intermediate dikes may be conservatively estimated by assuming that the toe of successive upgradient dikes should be at the same elevation as the crest of the preceding downgradient dike. The spacing may be increased if the approach recommended by Heede (1976) is used. Heede's approach incorporates the field observation that the slope of the gully infilling behind a gully control dike is not horizontal but inclined. The inclination is a function of site-specific factors, but on average appears to be about fifty percent of the pre-gully slope surface.

In designing a soil cover, the potential for biointrusion must be considered. Figure 10.3 tabulates the factors involved in the evaluation of cover components for biointrusion control.

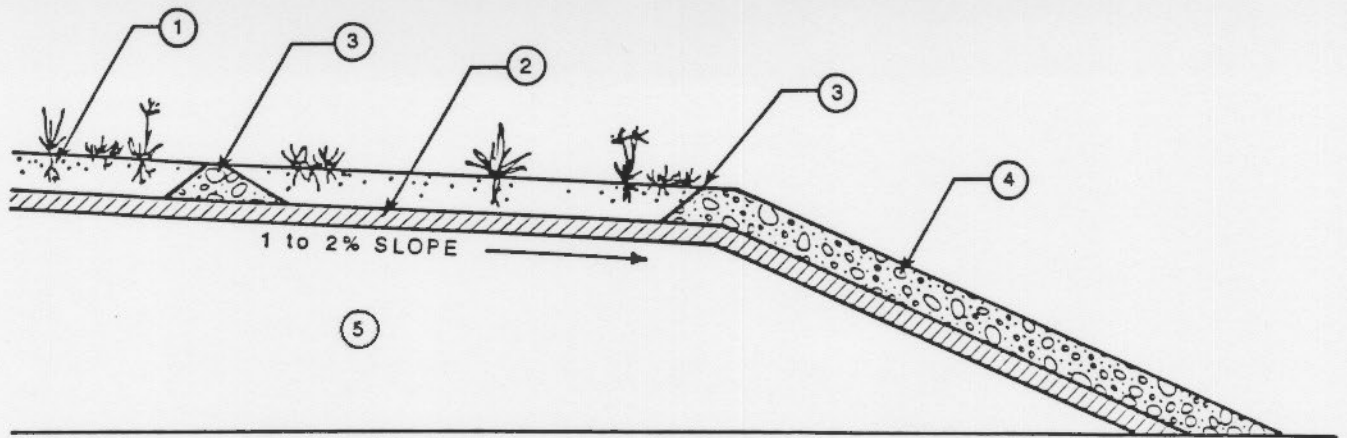

- ① UPPER TOP LAYERS: FILTER, BIOINTRUSION BARRIER, SOIL, & VEGETATION
- ② LOWER TOP LAYERS: RADON & INFILTRATION BARRIER
- ③ GULLY EROSION INHIBITORS: ROCK BERMS OR DIKES
- ④ SIDESLOPE EROSION BARRIER: ROCK
- ⑤ TAILINGS & CONTAMINATED MATERIAL

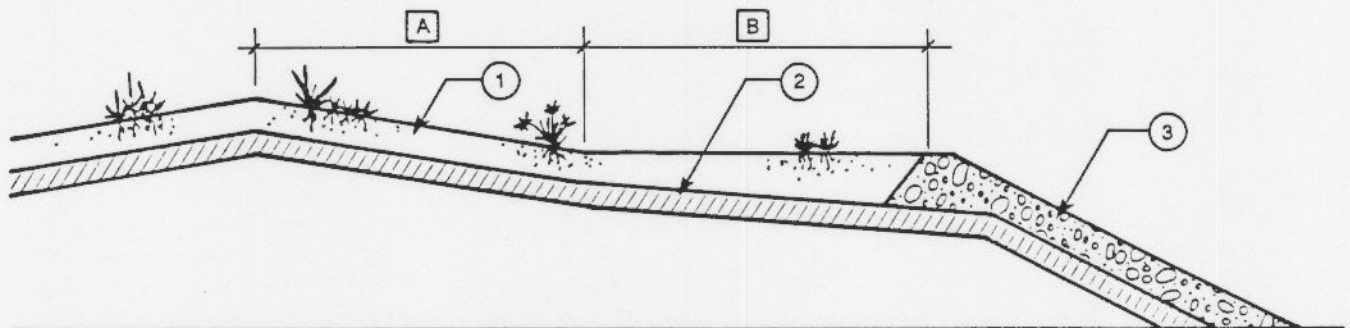

- Ⓐ INCLINED SLOPE: LENGTH LESS THAN CRITICAL TO INITIATE GULLY
- Ⓑ FLAT SLOPE: NO GULLY DEVELOPMENT POSSIBLE

**FIGURE 10.1**  
**COVER DESIGN CONCEPTS FOR PREVENTION OF GULLIES**

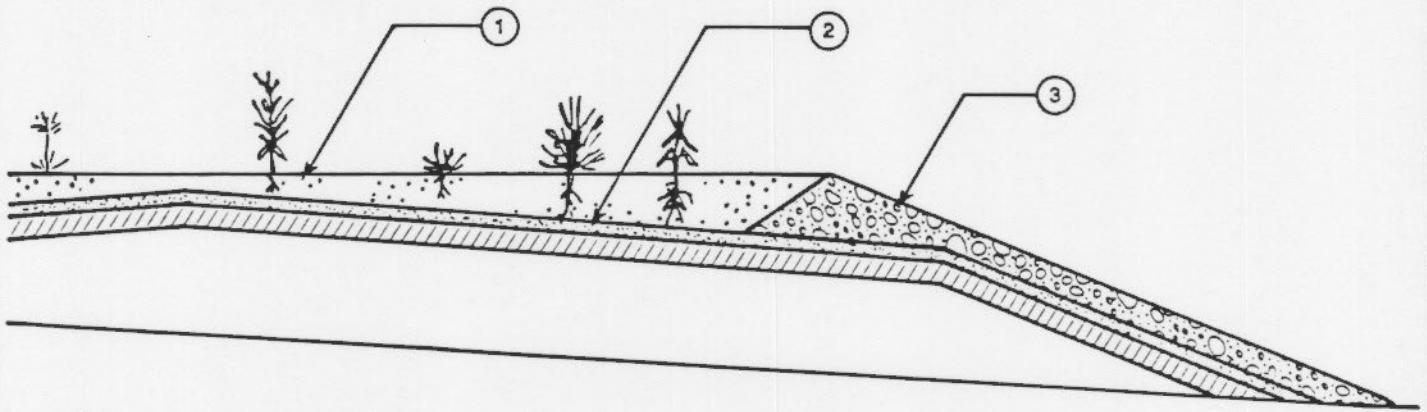

- ① FLAT TOPSLOPE
- ② INCLINED DRAIN & INFILTRATION BARRIER
- ③ SIDESLOPE WITH EROSION CONTROL ROCK

**FIGURE 10.2**  
**COVER WITH INCLINED DRAINAGE LAYERS AND FLAT TOP**

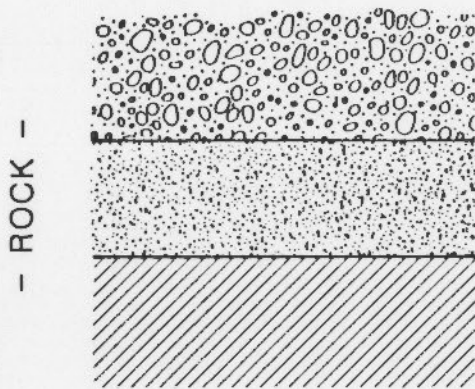

ROCK LAYER: the thicker the better (for resisting biointrusion)

ROCK SIZE: the smaller the better

FILTER LAYER: thickness does not matter

FILTER PERMEABILITY: the more permeable the better

RADON BARRIER: the thicker the better

BARRIER TEXTURE: the more clayey the better

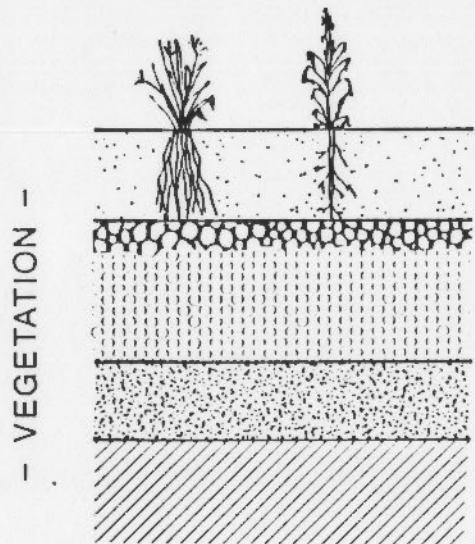

VEGETATION: the grassier the better

ROOTING MEDIUM: the thicker better

ROOTING MEDIUM: the more capillary pores the better

BIOBARRIER: the fewer capillary pores the better

FILTER LAYER: the more permeable the better

RADON BARRIER: the thicker the better

BARRIER TEXTURE: the more clayey the better

**FIGURE 10.3**  
**FACTORS IN THE EVALUATION OF COVER COMPONENTS FOR BIOINTRUSION HAZARD**



## 11.0 IMPACT OF STANDARDS ON ALL SITES

### 11.1 SPECIAL STUDY IMPLICATIONS TO CELL DESIGN

Table 11.1 summarizes the impact that the engineering special studies have had on the UMTRA Project disposal cell design. Shown on the Table for each study is whether or not the positive findings from the study have been incorporated into the design of the site cell and cover. In general we believe that the data indicate the significant impact of the studies on cell and cover designs.

### 11.2 SITE-SPECIFIC ANALYSIS

The following is a brief summary of the impact of the proposed EPA groundwater standards on all UMTRA Project sites. Technical details of the cell and cover designs for four selected sites are discussed in the next section.

- o Ambrosia Lake: The hydraulic conductivity of the filter has been increased. This does not result in a significant cost increase.
- o Belfield/Bowman: The cover thickness has been increased to provide frost protection at a cost of about \$400,000.
- o Cannonsburg: No impact, as the disposal cell was complete before the standards were proposed.
- o Durango: The cover has been significantly altered--see next section for a detailed discussion of the changes.
- o Falls City: Detailed evaluations have not been completed, but it is anticipated that significant cell and cover design changes will have to be made to achieve compliance with the proposed EPA groundwater standards.
- o Grand Junction: A new cover design was formulated--see next section for details.
- o Green River: The cover design has been altered by adding a frost protection layer and a higher permeability filter, and adding sodium bentonite to the radon/infiltration barrier to reduce its permeability. The estimated additional cost of these measures is about \$100,000.
- o Gunnison: The tailings are to be relocated to a new site where the constrained cell with a very low permeability cover will be constructed--see next section for details.
- o Mexican Hat: No significant changes, except that the pile will now incorporate material from Monument Valley.

Table 11.1 Application of Special Study Findings at specific sites: impact on cell design

Site	Geomembrane	Alternate cover materials	Alternate cover design	Freeze thaw	Veg.	Radon barrier M.C.
AMB	N	N	Y	N	N	Y
BOW	N	N	Y	Y	T	N
CAN			NA			
DUR	N	Y	Y	Y	Y	N
FCT	N	Y	Y	N	Y	N
GRJ	Y	Y	Y	Y	Y	Y
GUN	N	Y	Y	Y	Y	Y
GRN	N	N	Y	Y	N	Y
HAT	N	N	N	N	N	Y
LKV	N	N	Y	N	N	N
LOW	N	N	N	N	N	N
MAY			TBD			
MON			NA			
NAT	N	Y	Y	Y	Y	Y
RFL	N	N	Y	Y	N	Y
SHP			NA			
SLK	N	N	Y	Y	N	Y
SPK	N	N	N	N	N	N
SLC			NA			
TUB	N	N	Y	N	N	Y
RIV			NA			

GEOMEMBRANE

N - A geomembrane not considered or proposed at the site  
 Y - A geomembrane considered for the site

ALTERNATE COVER MATERIALS

N - CLAYMAX not likely to be incorporated into cover  
 Y - CLAYMAX likely to be incorporated into cover

ALTERNATE COVER DESIGN

N - Increased permeability drain not required  
 Y - Permeability of the drain to be increased

FREEZE/THAW

N - Additional material for freeze/thaw protection not required  
 Y - Additional material for freeze/thaw protection required

VEGETATION

N - Vegetation not likely to be used at the site  
 Y - Vegetation likely to be used at the site  
 T - To be determined

RADON BARRIER MOISTURE CONTENT

N - Partially saturated conditions not likely to occur  
 Y - Partially saturated conditions likely to occur

- o Lakeview: No significant changes.
- o Maybell: No evaluation of the design changes required to comply with the EPA groundwater standards has yet been made. We anticipate that some changes in cover design may be required.
- o Monument Valley: Tailings will be relocated to and codisposed with the Mexican Hat tailings.
- o Naturita: The constrained cell design will probably be adopted.
- o Rifle: A frost protection layer costing about \$2 million will be added to the cover.
- o Shiprock: No change, as remedial work was complete before the standards were proposed.
- o Slick Rock: Detailed design reevaluations have not been undertaken, although it appears likely a frost protection layer will have to be added at a cost of about \$125,000.
- o Spook: A layer of CLAYMAX may be placed over the pile in order to facilitate proving to the NRC that ACLs are not required.
- o Salt Lake City: No change, as construction was almost completed at the time the standards were proposed.
- o Tuba City: The infiltration barrier will be placed at an hydraulic conductivity of  $1 \times 10^{-8}$  cm/s. To confirm the feasibility of this, a test pad was constructed.
- o Riverton: No affect, as the tailings are being relocated to a Title II facility.
- o Lowman: A frost protection layer may be added at a cost of \$100,000.

### 11.3 COST IMPLICATION

The most significant impact on disposal cell design at individual UMTRA Project sites has been on the cover. The single most significant impact on cover design has been the realization that it is imperative to protect the infiltration barrier from freezing, hence in the long-term maintain its low permeability and its ability to comply with the proposed EPA groundwater standards. The estimated total cost increase to the UMTRA Project as a result of providing frost protection is about \$10 million.

Relocation of the Monument Valley tailings will cost about \$10 million more than stabilization on the site in accordance with the design formulated before the appearance of the proposed EPA groundwater standards.

Precise comparative figures for the increased cost of more complex covers at sites like Durango and Grand Junction are not available. It is, however, not unreasonable to put the increased cost at about \$1 million per site. The likely increased cost of new cover designs at Gunnison, Falls City, Naturita, and Maybell has not been evaluated, but again a rough estimate of \$1 million per site is not unreasonable. Hence we may conclude that the total cost impact of the proposed EPA groundwater standards on disposal cell cost is between \$20 and \$30 million.



## 12.0 CASE HISTORIES

### 12.1 GRAND JUNCTION

Figure 12.1 shows the design of the proposed cover for the disposal cell at Cheney Reservoir, the site to which the tailings and contaminated materials from Grand Junction will be relocated. This design has been proposed to the NRC, and discussions with them about its acceptability continue.

The topslope cover incorporates most of the elements of the checklist cover. Soil and vegetation are the primary infiltration barriers, augmented by a CLAYMAX mat placed above the radon barrier. Beneath the soil is a filtered biointrusion barrier and beneath that is a drain of clean sand. The radon barrier is compacted silts and clays. The slope of the top surface is two percent. This is considered just sufficient to promote shedding of water that may enter the drain above the CLAYMAX in the rare event of seepage from the soil. A significant factor affecting the choice of the relatively flat topslope is the need to minimize the potential for erosion of the soil. Geomorphological evidence indicates that slopes of that inclination are unlikely to experience significant gully development during the design life of the pile. If this thesis is acceptable to the NRC, the only other erosion control feature will be the establishment of an erosion base level at the perimeter of a perimeter dike of erosion resistant rock. If the NRC is unable to accede to this approach, then it may be necessary to incorporate erosion control dikes at regular intervals up the slope as shown in Figure 10.1. These would be easy to build; however, because of the extraordinary concern for quality and control on the UMTRA Project they will be difficult and expensive to build.

Rock, not soil, is the uppermost component of the topslope. Because of the very small amount of water that will flow off the topslope, it is believed that the sideslope radon barrier will be partially saturated. Hence, its operative hydraulic conductivity will be very low (less than the saturated hydraulic conductivity of about  $1 \times 10^{-7}$  or  $-8$  cm/s at which it would be placed.) Because of the anticipated low permeability of the radon barrier, it will double as the sideslope infiltration barrier, and CLAYMAX will not be used there. Frost protection is not provided on the sides as the partially saturated state of the infiltration barrier precludes damage by freezing. (If this thesis is considered unacceptably unconservative by the NRC, a sideslope cover design detail such as that shown for Durango, Figure 12.4, may have to be considered.)

### 12.2 GREEN RIVER

At Green River the tailings are to be stabilized on the site and placed partially in an excavation and partially above grade. The upper section of Figure 12.2 shows the general layout of the perimeter of the cell.

The proposed cover incorporates a radon/infiltration barrier amended with bentonite to produce a low hydraulic conductivity (the bentonite was added as a direct result of the need to comply with the proposed EPA groundwater standard). Over the radon/infiltration barrier is a drain, frost protection random fill, and an erosion barrier of durable rock and bedding.

The compliance strategy at Green River includes ACLs for selected constituents. In order to support an ACL application, it is necessary to evaluate alternate disposal cell and cover details. The lower section of Figure 12.2 shows the main alternate perimeter detail considered for the Green River disposal cell and cover. The alternate cover incorporates CLAYMAX and a perimeter dike of clean compacted material. Detailed studies have shown that this alternate perimeter detail does not lead to a lesser groundwater impact, and is in addition more costly than the proposed detail. Accordingly it is not adopted for use.

### 12.3 GUNNISON

The tailings from the Gunnison pile will be relocated to the Landfill site. The proposed cell and cover details are shown on Figure 12.3. The "constrained cell" approach has been selected. In addition, the cover incorporates most of the elements of the checklist cover, including CLAYMAX and vegetation as the interactive infiltration control mechanism. This conservative approach is adopted in order to achieve MCLs (to the extent possible) at the new disposal site.

The perimeter detail includes dikes of clean compacted soil. The inner slopes of these dikes will be arranged to preclude backseepage of water, coming off the topslope, into the tailings. This will be achieved either by a pronounced slope, as much as two to one, or by introducing anisotropy into the dike by selective construction practices (inclined layer placement with smooth rolling of successive lift). The side dikes of clean material are selected primarily to reduce contaminant seepage from the cell. Because of the wet, cold climate at the site, partially saturated flow conditions are unlikely to prevail in a radon barrier of a sideslope with conventional details (as shown in Figure 12.1). As the saturated flow through a conventional sideslope is likely to result in too great a contaminant flow rate, it is necessary to place clean material and eliminate contaminated seepage from beneath the sideslopes.

The topslope design is essentially the same as that discussed above for Grand Junction, except that the soil layer thickness is increased to provide the required site-specific frost protection depth.

## 12.4 DURANGO

At the time of the first appearance of the EPA groundwater standards, the relocation of tailings from the processing site to the new disposal site at Bodo Canyon was well advanced. The only reasonable design modification possible to enhance groundwater standards compliance was to change the cover details. Alteration of the sideslope inclination was considered, but the cost and construction implications did not yield a commensurate increased compliance potential.

After considerable evaluation, the details for the cover as shown on Figure 12.4 were recommended. As at Grand Junction and Gunnison, the topslope incorporates vegetation and CLAYMAX as the operative infiltration barriers. The radon barrier doubles as the infiltration barrier. In order to protect the radon/infiltration barrier from the deleterious effects of freezing, a frost protection layer is placed above the radon/infiltration barrier. Between the two is placed a drain. This prevents build up of an hydraulic head on the infiltration barrier that would then increase seepage through the infiltration barrier.

The connection between the topslope and the sideslope cover is shown in the Figure 12.4. The detail adopted creates a coarse rock "ledge" around the perimeter of the topslope. This ledge functions as an erosion control base level.



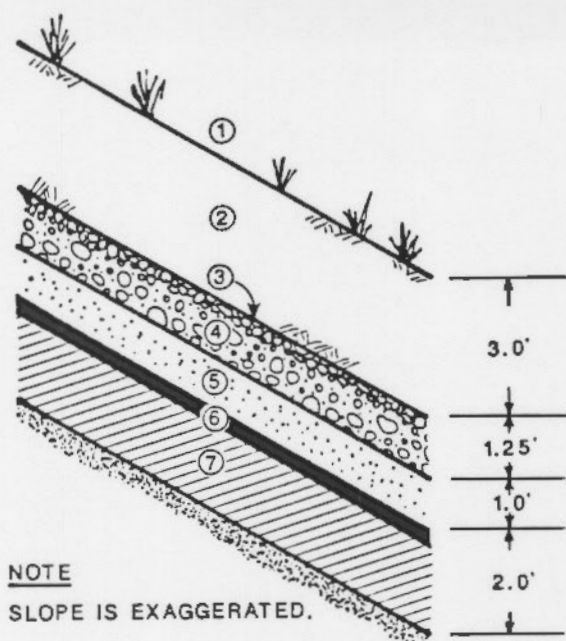

NOTE  
SLOPE IS EXAGGERATED.

- 1. VEGETATION: SELF-SUSTAINING COMMUNITY
- 2. SOIL: NATURAL & AMENDED GROWTH MEDIUM
- 3. FILTER
- 4. BIOINTRUSION
- 5. DRAIN: CLEAN SAND
- 6. INFILTRATION BARRIER: CLAYMAX<sup>®</sup>
- 7. RADON BARRIER: LOW-PERMEABILITY CLAY

TOP COVER

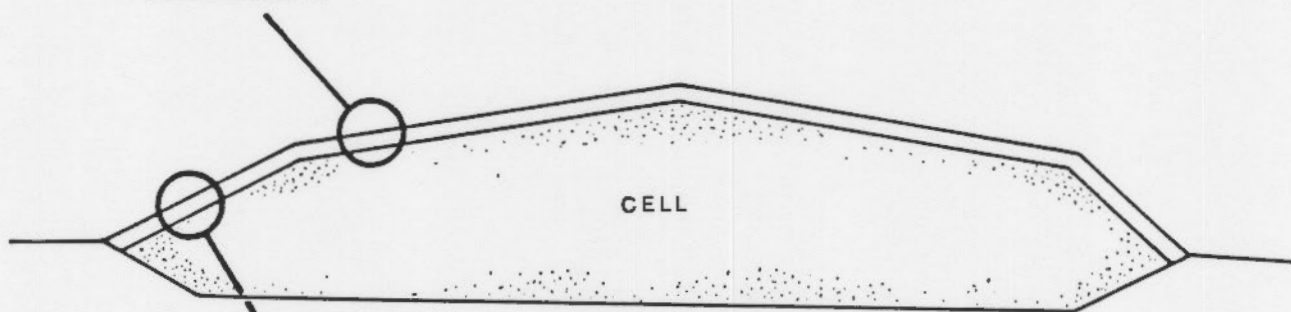

SCHEMATIC - NOT TO SCALE

SIDE SLOPES COVER

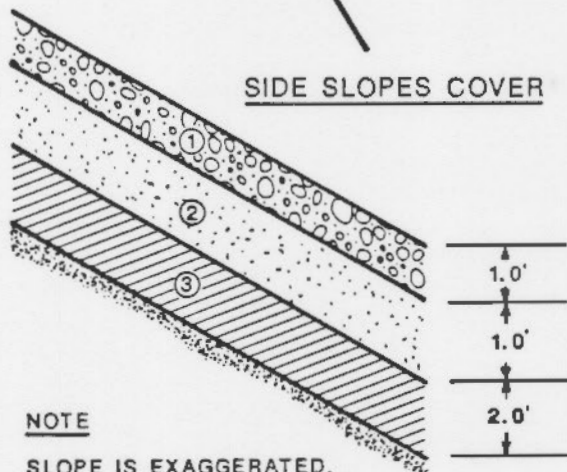

NOTE  
SLOPE IS EXAGGERATED.

- 1. EROSION BARRIER: DURABLE ROCK
- 2. DRAIN: CLEAN SAND
- 3. INFILTRATION BARRIER & RADON BARRIER: LOW-PERMEABILITY CLAY

FIGURE 12.1  
GRAND JUNCTION PROPOSED COVER DESIGN



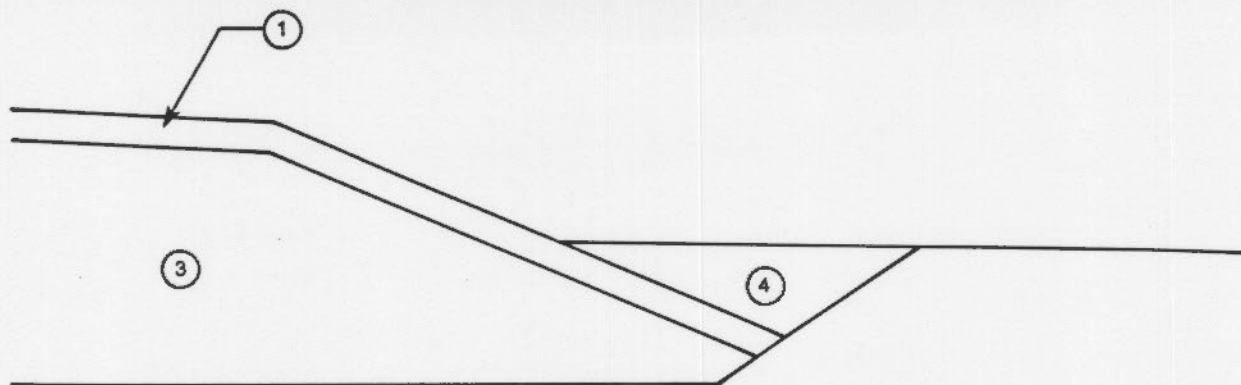

PROPOSED PERIMETER DETAIL

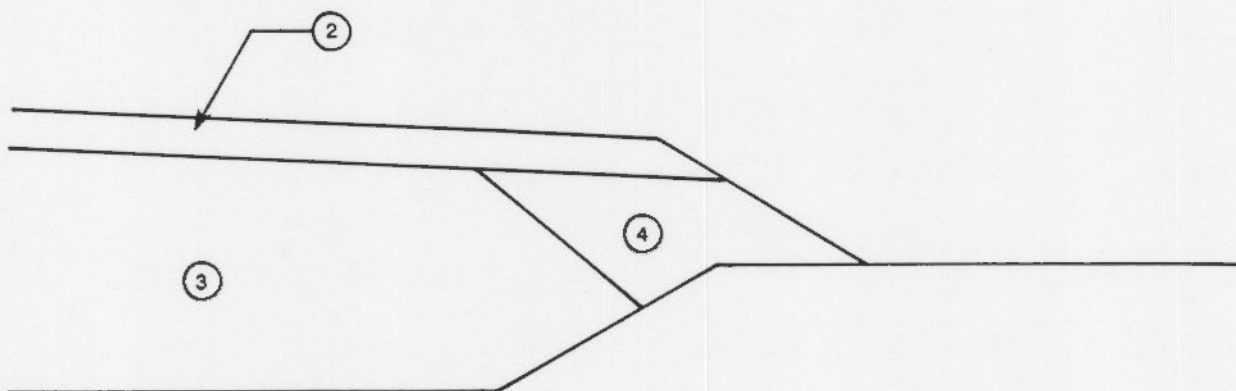

ALTERNATE PERIMETER DETAIL

- ① COVER: RADON BARRIER, DRAIN, FROST PROTECTION, EROSION BARRIER
- ② COVER: INCORPORATING CLAYMAX<sup>®</sup> AS INFILTRATION BARRIER
- ③ TAILINGS & CONTAMINATED MATERIAL
- ④ CLEAN FILL

**FIGURE 12.2  
GREEN RIVER DISPOSAL CELL: ALTERNATE PERIMETER DESIGNS**

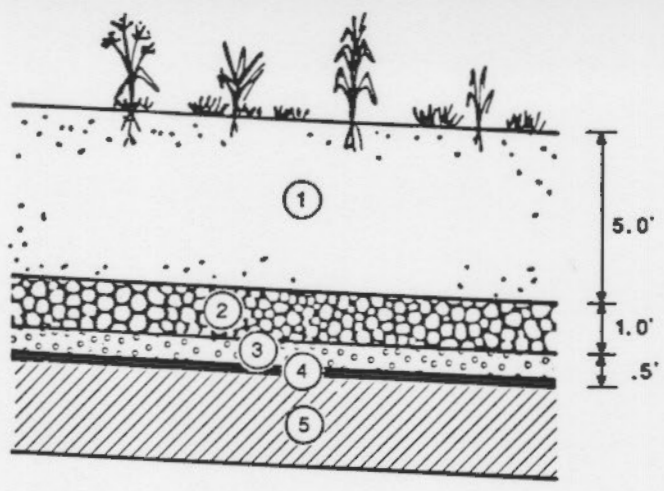

VEGETATION

- ① FROST PROTECTION & GROWTH LAYER: RANDOM SOIL
- ② BIOINTRUSION: COBBLES
- ③ DRAIN: SAND & GRAVEL
- ④ INFILTRATION BARRIER: CLAYMAX
- ⑤ RADON BARRIER: CLAY & SILT

TOP COVER DETAIL

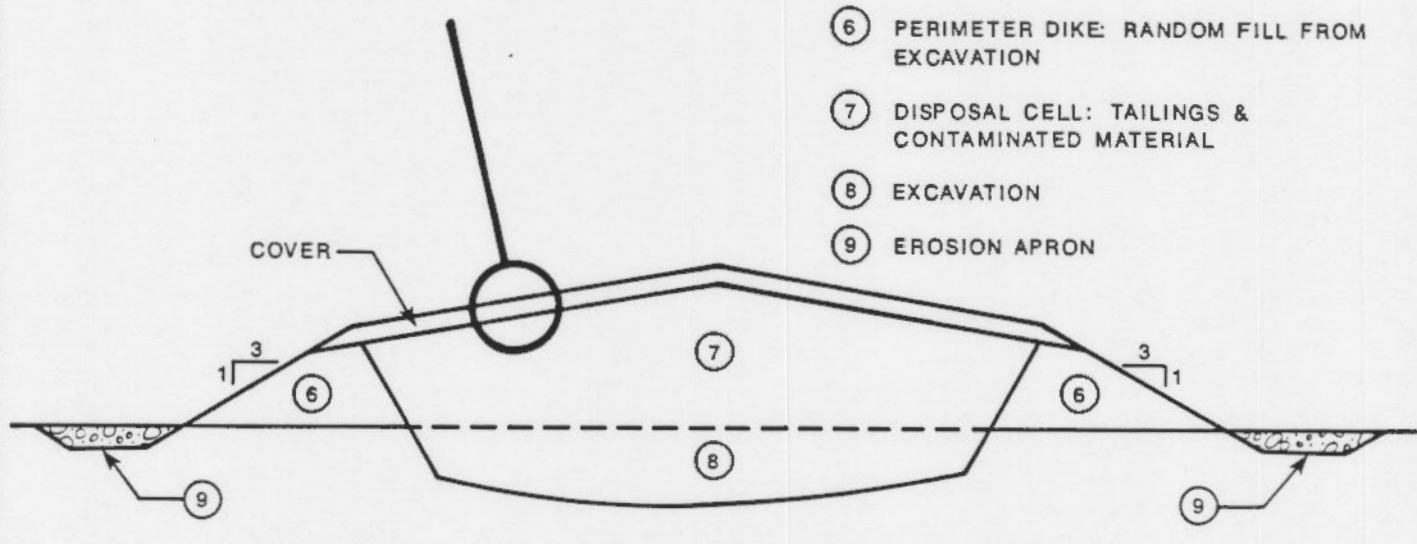

- ⑥ PERIMETER DIKE: RANDOM FILL FROM EXCAVATION
- ⑦ DISPOSAL CELL: TAILINGS & CONTAMINATED MATERIAL
- ⑧ EXCAVATION
- ⑨ EROSION APRON

CROSS SECTION THROUGH DISPOSAL CELL

**FIGURE 12.3  
DISPOSAL CELL DETAILS  
LANDFILL  
GUNNISON, COLORADO**

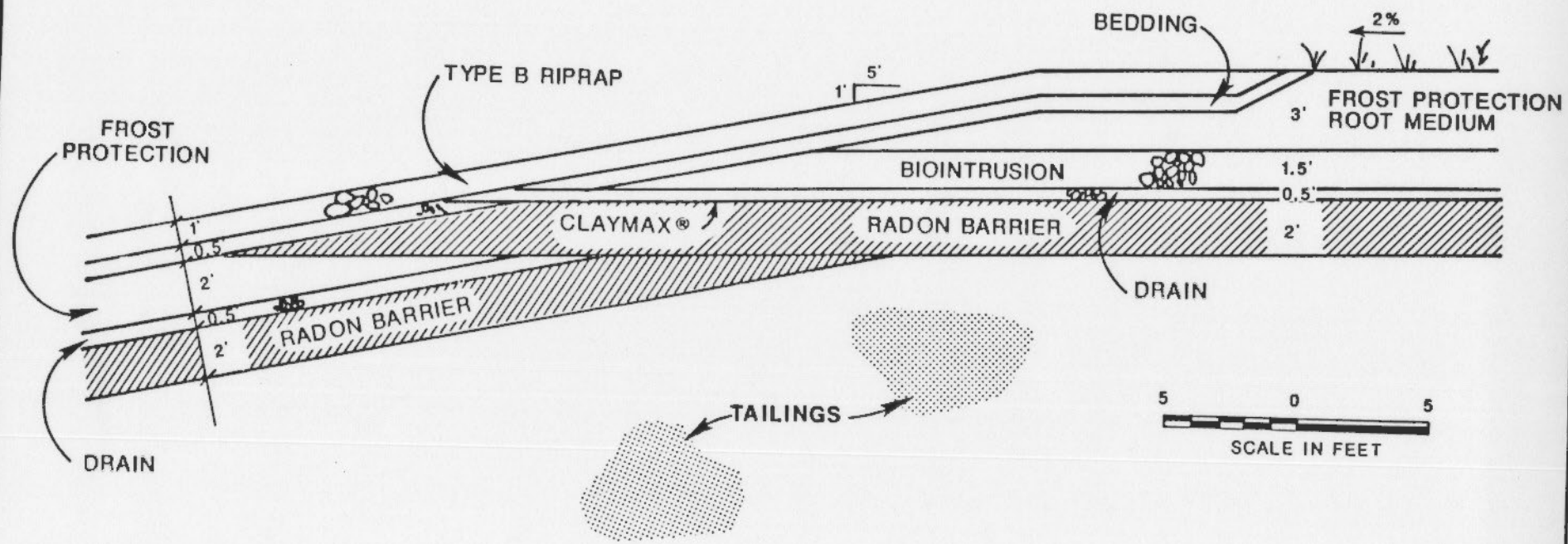

FIGURE 12.4  
FINAL COVER DESIGN  
DURANGO, COLORADO

## REFERENCES

- U.S. Department of Energy. (1988) "Uranium Mill Tailings Remedial Action Project. Technical Approach Document." Document 050425.0000 Revision 1. DOE Albuquerque, New Mexico.
- Heede. B.H. (1976) "Gully Development and Control" USDA Forest Service Research Paper RM-169. U.S. Department of Agriculture. Fort Collins, Colorado 80521.
- Miller, L.L. and Davis, L.A., (1978) "Hydrogeology Aspect of Reclamation of the Ray Point Tailings Facility." in Geotechnical and Geohydrologic Aspects of Waste Management, D.J.A. van Zyl et al., Eds., Lewis Publishers, Inc., Chelsea, Michigan.
- Mitchell, J.K., (1976) "Fundamentals of Soil Behavior." John Wiley & Sons, Inc. New York.
- Shepherd, T.A. and Abt. S.R., (1987) "A Comparison of Reclamation Plans at Title I and Title II Uranium Mill Tailings Sites." Presented orally at an ASCE Conference. Written copies from Water, Waste & Land, Inc., 2629 Redwing Road, Suite 200, Fort Collins, Colorado, 80526.



COMPONENT ELIMINATION CRITERIA

ATTACHMENT A

Component Elimination Criteria for  
"Checklist" Cover

Cover Component	Purpose & Function	Rationale for Elimination (based on site-specific conditions)
1. Erosion-Barrier Vegetation ( <u>topslopes only</u> ).	<ul style="list-style-type: none"> <li>o Transpire moisture that enters soil.</li> <li>o Reduce infiltration.</li> <li>o Stabilize soil and reduce erosion.</li> <li>o Minimize impact of rainsplash.</li> </ul>	<ul style="list-style-type: none"> <li>o Unavailability* of suitable topsoil to support vegetation; topsoil is highly erodible because of physical structure or properties.</li> <li>o Short growing season (BEL/BOW).</li> <li>o Arid environment (MON/HAT).</li> <li>o Unavailability of "high" quality large diameter rock for protection against gully intrusion, if topslopes are greater than 1%. Although it may be desirable to design 1% (or less) topslopes, area constraints, restriction on subgrade disposal or a combination, thereof, may preclude gentle/flat topslopes.</li> <li>o Unavailability of "high" quality rock for the biointrusion layer (G. Lindsey proposes that rock quality would have to meet the same requirements as that for frequently saturated conditions-scoring 65% or better).</li> <li>o Piles at which it is possible to show that a significantly thick rock layer can be placed to inhibit the</li> </ul>

\*Availability encompasses volume, quality and size (for rock only).

Component Elimination Criteria for  
"Checklist" Cover (Continued)

Cover Component	Purpose & Function	Rationale for Elimination (based on site-specific conditions)
		<ul style="list-style-type: none"> <li>o establishment of vegetation.</li> <li>o Pile at which construction is complete.</li> <li>o Piles for which design is too far advanced to change.</li> </ul>
2. Erosion-Barrier- Small diameter rock layer above topsoil on peagravel/soil mulch ( <u>topslopes only</u> ).	<ul style="list-style-type: none"> <li>o Provide additional protection against soil erosion used in conjunction with vegetation.</li> <li>o Reduce evaporation rates within the underlying soil layer in drier environments-increase infiltration.</li> </ul>	<ul style="list-style-type: none"> <li>o Vegetation would not be used for any of the reasons stated in No. 1 above.</li> <li>o Wet, humid environment (semitropical).</li> <li>o Unavailability of rock.</li> <li>o Inhibits vegetal growth.</li> </ul>
3. Rooting Medium (2-3 feet of soil) ( <u>topslopes only</u> ).	<ul style="list-style-type: none"> <li>o Provide rooting medium for vegetation.</li> <li>o Store water for plant growth.</li> <li>o Protect the underlying biointrusion layer from surface exposure.</li> </ul>	<ul style="list-style-type: none"> <li>o Vegetation would not be used for any of the reasons stated in No. 1 above.</li> </ul>
4. Frost Protection (random fill) ( <u>top &amp; sideslopes</u> ).	<ul style="list-style-type: none"> <li>o Protect the underlying layers from the effects of frost heave and penetration.</li> <li>o Preserve the physical properties of the underlying layers.</li> </ul>	<ul style="list-style-type: none"> <li>o Regional frost penetration depth is insignificant; and protection, if required, can be afforded by the erosion barrier or rooting medium (if included).</li> <li>o Piles at which construction is complete.</li> <li>o Piles for which the design is too far advanced to change.</li> </ul>
5. "Choked" Rock Filter (layer of peagravel overlying layer of	<ul style="list-style-type: none"> <li>o Prevent piping of soil into erosion/biointrusion barrier.</li> </ul>	<ul style="list-style-type: none"> <li>o If biointrusion layer were not to be used for any of the reasons</li> </ul>

Component Elimination Criteria for  
"Checklist" Cover (Concluded)

Cover Component	Purpose & Function	Rationale for Elimination (based on site-specific conditions)
coarse aggregate) ( <u>top &amp; sideslopes</u> ).	o Drain infiltration as rapidly as possible to retard root growth.	o stated in No. 6 below. o Potential for slope instability-particularly on sideslopes.
6. Erosion/biointrusion 2-3 feet of cobbles with a low coefficient of uniformity biointrusion ( <u>top and sideslopes</u> ).	o Drain infiltration as rapidly as possible to retard root growth. o Impede burrowing animals o Act as a capillary break at the bottom of the layer to prevent upward movement of water. o Control topslope erosion if vegetation and topsoil eroded away.	o <u>Biointrusion layer</u> o Will not be protected from surface exposure by an overlying layer (i.e. topsoil, random fill rock). o Unavailability of "high" quality rock (frequently saturated conditions). o Piles at which construction is complete. o Piles for which the design is too far advanced to change.
7. High permeability drain (6"-1' layer of peagravel overlying clean sand).	o Drain water laterally off the pile to limit infiltration. o Protect the underlying Claymax <sup>R</sup> liner system from displacement and rock penetration.	o Do not have underlying Claymax <sup>R</sup> liner system for any of the reasons stated in No. 8 below. o Potential for slope instability-particularly on sideslopes.
8. Infiltration Barrier-Claymax <sup>R</sup> liner system ( <u>topslopes only</u> ).	o Intercept moisture. o Control infiltration. o Inhibit infiltration while mature vegetation community is establishing.	o Saturated hydraulic conductivity of radon barrier, amended or not, is low enough to lead to groundwater compliance. o Potential for slope instability. o Piles at which construction is complete. o Piles for which the design is too far advanced to change.
9. Radon Barrier (clay/silt) ( <u>top &amp; sideslopes</u> ).	o Inhibit radon emanation. o Limit infiltration.	o Rationale for reducing thickness-Claymax <sup>R</sup> liner system aids in radon gas diffusion.